



## INSTALLATION INSTRUCTIONS

### The Harvia Legend Sauna







*Read these instructions to guide your assembly. Check the contents of delivery without delay!  
Study the instructions and keep for future reference.*



*Manufactured By:*



# Contents of Delivery

		Your sauna.	1
The following parts are packed inside of the sauna			
1.		Cover strip for pallet (front and back)	2
2.		Terrace screws RST 4,2 x 55 mm Wubau TX20 (Brown)	12
3.		Door handle	1
4.		Door lock (incl. 1 x lock, 2 x key, 1 x latch)	1
5.		Stool	1
6.	Accessory box: User manual, 0,5l stain for outer walls, brushes, gloves and matches		

## Contents of Delivery with electric heater

1.		Harvia Legend Pro PE11, 11 kW	1
2.		Hearth plate	1
3.		Sauna heater stones (small)	2
4.		Sauna heater stones (large)	4

## Contents of Delivery with wood heater

5.		Harvia Legend 240 / Harvia Legend 240 Green-Flame	1
6.		Harvia WL300 smoke pipe guard	12
7.		Protective bedding	1
8.		Hearth plate	1
9.		Sauna heater stones (large)	10
10.		Sauna heater stones (small) For smoke pipe guard	2
11.		Smoke damper Harvia Steel (Only in Finland and Sweden)	1

12.		Steel Chimney	1
-----	-----------------------------------------------------------------------------------	---------------	---



12 A.		Steel Pipe	1
12 B.		Smoke pipe	1
12 C.		Lead-through flange	2
12 D.		Screws for Lead-through flange 4,2x13 wronic	8
12 E.		Lead-through insulation	2
12 F.		Clamp for insulation	1
12 G.		Silicon	1
12 H.		Rain flange	1
12 I.		Clamp for Rain flange	1
12 J.		Screws for Rain flange	1
12 K.		Rain Cap	1
12 L.		Screws for upper end of steel pipe	3

## CHECKING THE DELIVERY

We recommend that you always check that you have received intact pallet before signing the waybill. If you notice later that there is something missing from the contents of the sauna, please contact the party that delivered the sauna.

## TRANSPORTING THE SAUNA AND LIFTING IT INTO PLACE

When transporting the module, the lifting slings, forklift tines or long pallet trucks must be placed under the module so that those supports the elements as well as possible throughout the lift and the module remains straight and the lifting capacity constant.

The modules are possible to transport with:

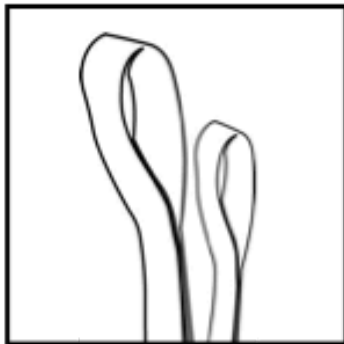

1. Lifting slings (Recommended to use when modules are lifted to the final place)

Make sure that the slings can withstand lifting.



2. Forklift tines (Recommended to use when the module is lifted off the truck)

**Tines must be at least two meters long**

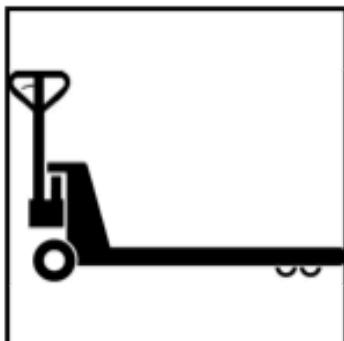

3. Pallet trucks (Recommended to use when the module is moved on the floor)

**Tines must be at least two meters long**

The module must be lifted from the side of the wall where this sign can be found. Straps / forklift tyres must be aligned with the marks.

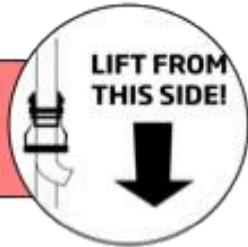

### Lifting with the slings



Set the slings from front of the module to the back.



Do not ever lift the module with slings set from side to side  
This will result in damage of the module.

### Lifting with the forklift

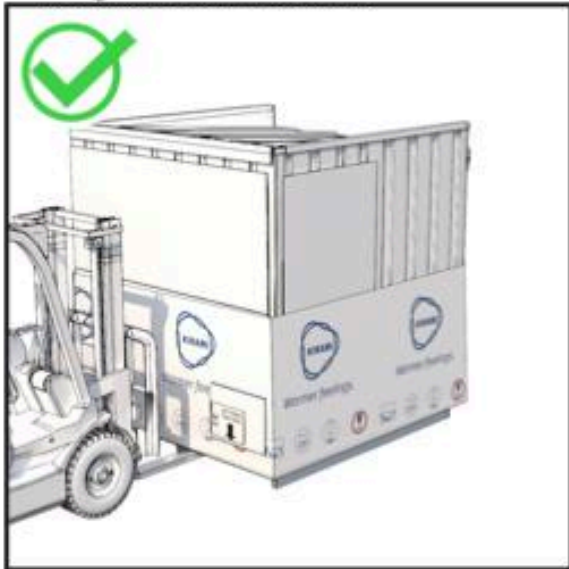

Drive forklift under the module from front.

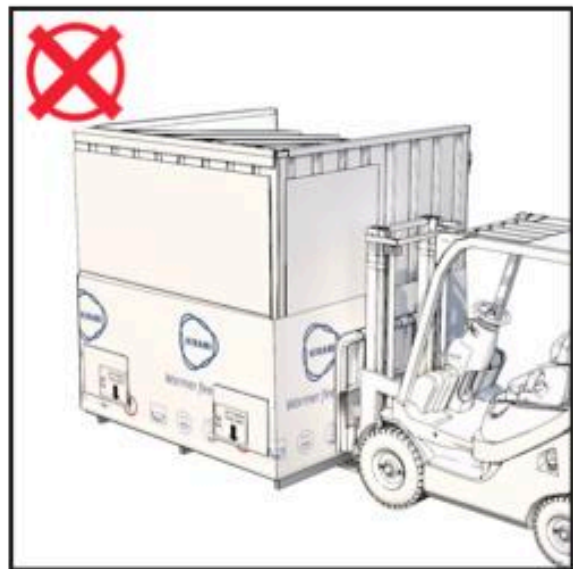

Do not ever drive the forklift from the side. This will result in damage of the module.

## Removing Transport protection

The sauna is delivered already assembled except for the sauna heater, flue, door handle, which are installed by the customer. During transport, the sauna's own base acts as the pallet, which means that the sauna can be placed directly on top of the foundation prepared by the customer.

Around the sauna is placed for transport:

1. Protective sheeting and bubble wrap
2. Plywood and boards (fixed with screws)
3. Protective plates on the side and front walls of the roof

Only remove the covers after the sauna has been placed in its final location to ensure that the glass in the sauna remains intact.

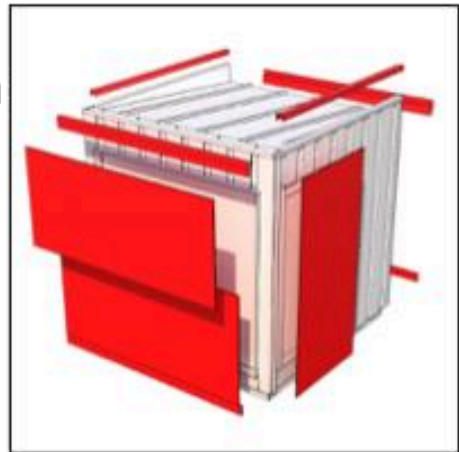

## Drainage

Small amounts of water are used in the sauna, either for cleaning the sauna or washing up. Choose the location of the sauna so that the drainage of water will not cause any problems.

There is a sewer in the sauna floor, and a water discharge pipe has already been attached to the sauna base. The discharge pipe can be found on the same side as the door. The discharge corner outlet pipe is 50 mm at the top. We recommend that you learn about the local regulations concerning the treatment of wastewater.

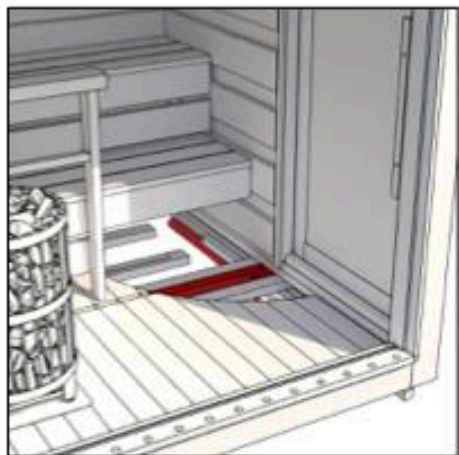

## Ventilation

The opening for incoming air has been placed near the sauna heater. The air exits through the exit air valve which can be found on the back wall.

The sauna room must be dried after each use of the heater/steamer. To speed up the drying process, the heater can be kept on and the sauna ventilation as high as possible. If the heater is used for drying, it must also be ensured that the heater has switched off after the set time.

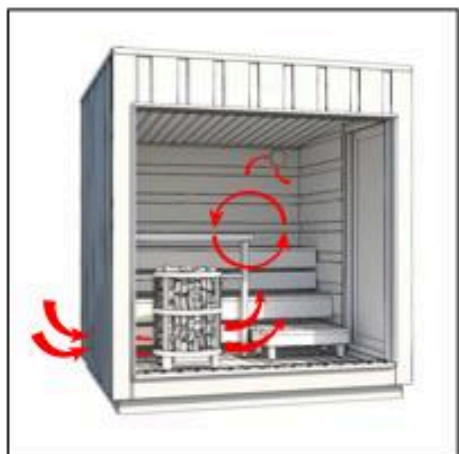

## FOUNDATIONS

Pay attention to potential maintenance activities when choosing where to install the sauna. The warranty does not cover any indirect costs, such as the demolition or construction of terraces. Before building a foundation, it is also good to prepare for the drainage of water from the sauna to its final location (the sauna already has its own drainage installed).

**Never place the sauna directly on the ground.** Make sure that the ground on which the sauna is placed is stable. If necessary, the base of the sauna can be evened out with stone chippings or a concrete casting can be made under the modules.

If you want to insulate the base, we recommend placing at least 5-10 cm of ground frost insulation under the gravel, which effectively cuts off the thermal bridge to the cold ground underneath.

Under the sauna, we recommend placing concrete slabs on top of the hard surface to lift it higher and putting roofing felt (bitumen roofing) on top of the slabs throughout the width of the slab.

When the base of the sauna is clearly up in the air, it has ventilation and dries well.

It is also important to ensure that the sauna is not surrounded by tall grass, because it prevents the wood from breathing and contributes to rotting. The lower parts of the sauna must always have enough ventilation.

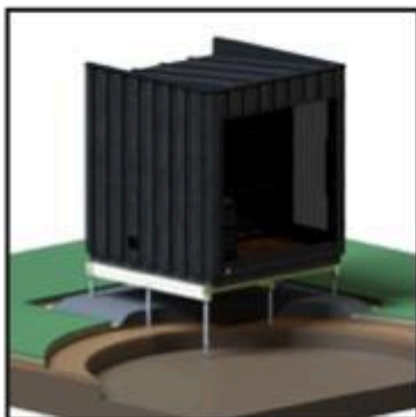
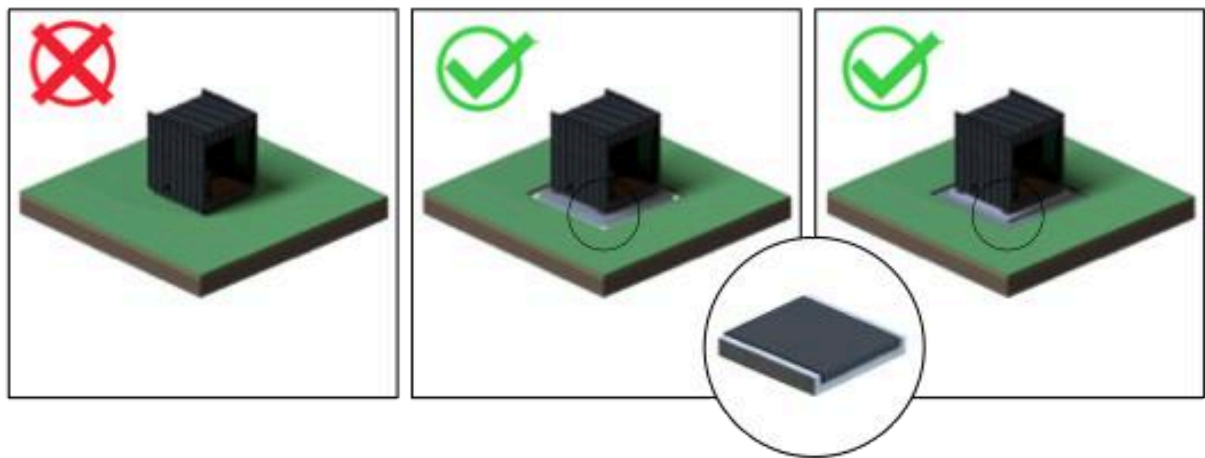

### Screw piles

There are various sizes, lengths and types of screw piles on the market. The selection is wide, because the choice of screw pile is also influenced by other things than the size and load capacity of the screw pile.

The appropriate model is selected according to the type of soil and the depth of the frost line.

You can install screw piles yourself, but ask a professional for advice on choosing a suitable model.

# Foundations - Concrete slabs

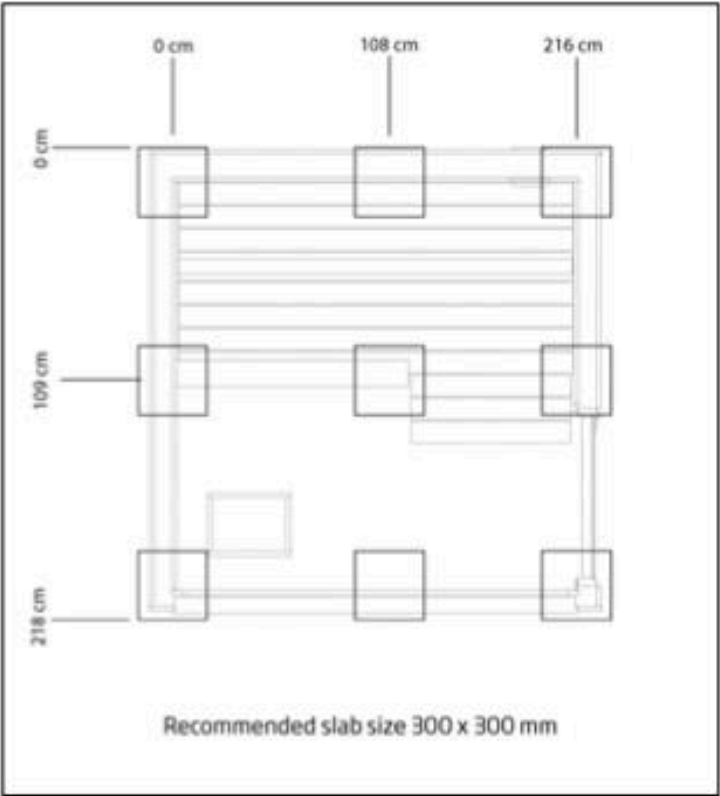

## SAUNA DOOR - ATTACHING AND LOCKING

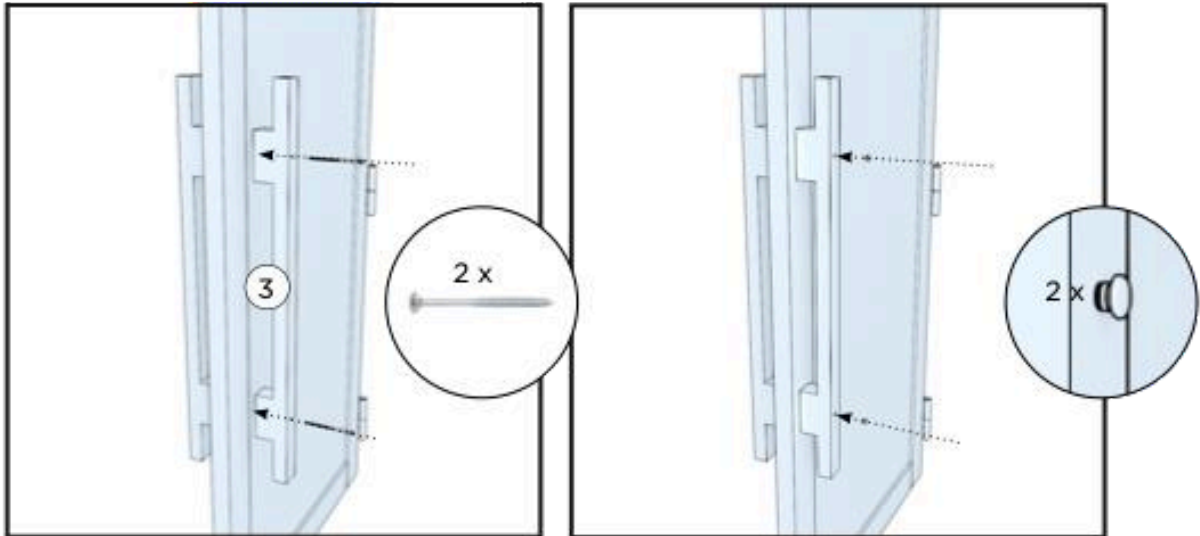

### ROLLER LATCH

The heat and humidity in the sauna as well as the variations in the temperature outdoors may cause changes in the tightness of the sauna door.

The tightness of the door can be adjusted by turning the screw of the roller latch.

It is good to oil the roller latch from time to time.

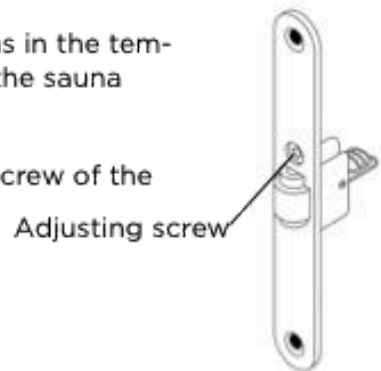

### Locking

The lock set includes a latch, padlock and 2 keys. The sauna is only locked when the sauna is not in use.

The lock stops the door from opening during rough weather and keeps children out of the sauna when adults are not around

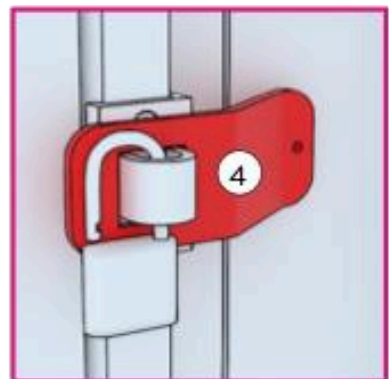

The sauna door must be locked when not in use. This prevents the door from opening and breaking, eg in stormy weather

## HARVIA LEGEND PRO P011 - ELECTRIC HEATER INSTALLATION AND USAGE

Note! Do not connect the sauna to the main power before you have installed heater.

The connecting cable to the sauna must be  $5 \times 2.5 \text{ mm}^2$  and the fuses  $3 \times 16 \text{ A}$ .

Harvia Cilindro is delivered in a separate package (the heater package can be found inside the sauna). There are more detailed instructions for installing and using the heater inside the package.

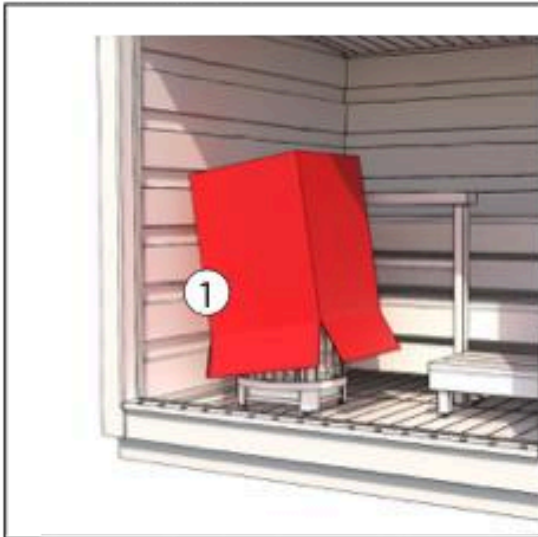

1. Remove the band around the heater package and carefully remove the cardboard box from the top because wires are already attached to the heater.

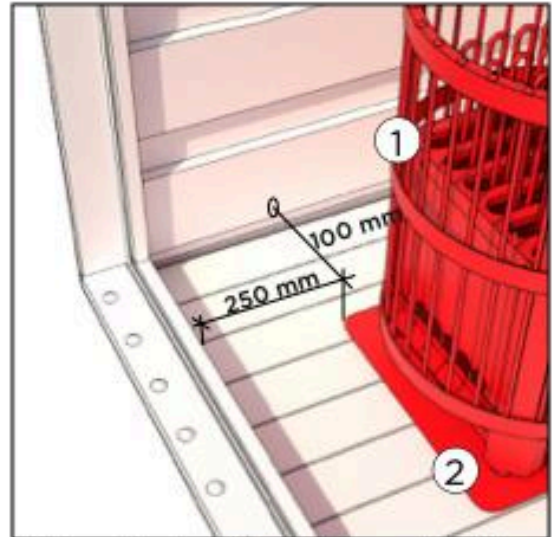

2. Place the heater plate on the floor according to the dimensions of the picture. Place heater on top of the hearth plate.



3. Put sauna heater stones in place. See the manual included in the sauna heater package for more detailed instructions.

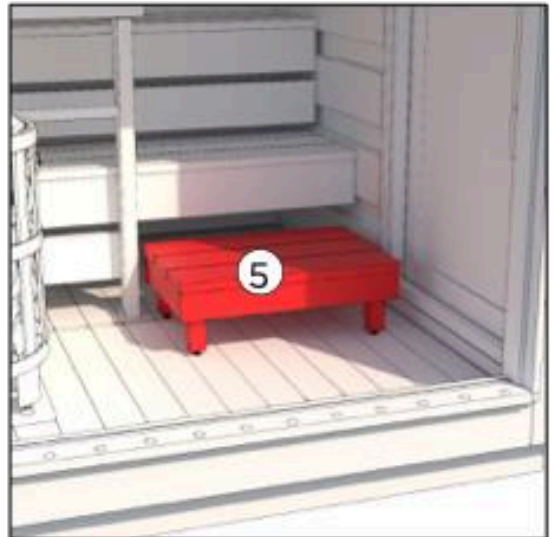

4. Place stool in place front of the bench.

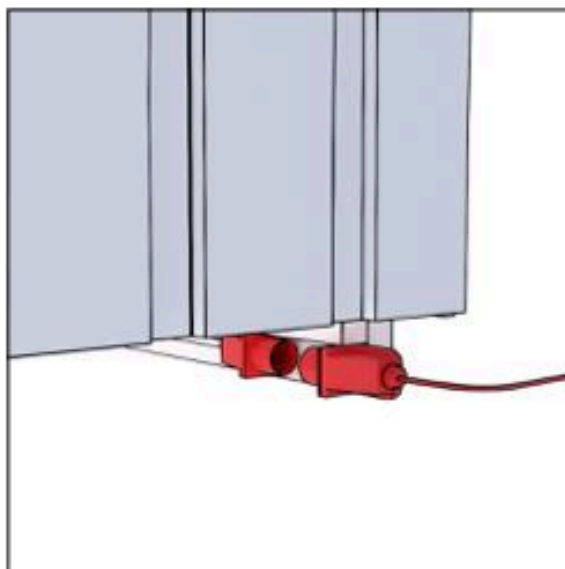

5. Connect the main power to the sauna. The connection can be found behind the sauna on the heater side. The Cable must be  $5 \times 2.5 \text{mm}^2$  and the fuses must be  $3 \times 16 \text{A}$ .

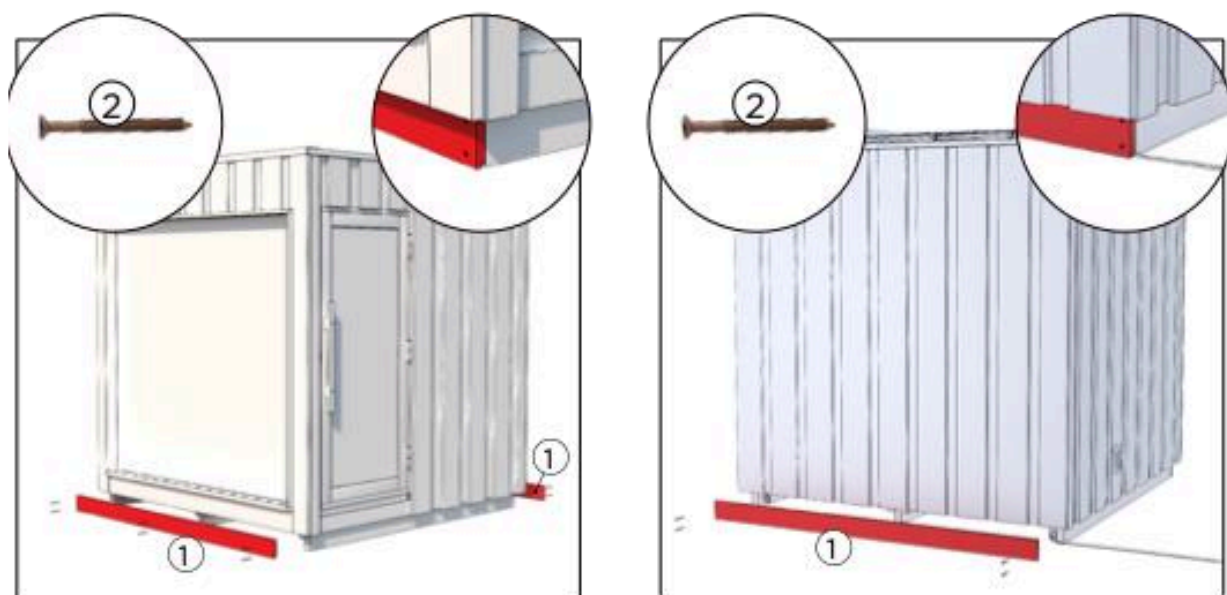

6. Install the cover strips on the transport supports at the front and rear with the 6 brown terrace screws.

Place the cover strips so that the grooves in the boards are facing down.

## HARVIA LEGEND PRO PO11 - USAGE

The control panel is meant for controlling the functions of sauna and an electric sauna heater.



SEE MORE DETAILED INSTRUCTIONS IN THE USER MANUAL SUPPLIED WITH THE CONTROL PANEL OR FROM THE LINK PROVIDED.

<https://mediabank.harvia.com/catalog/Harvia/r/6228/viewmode=previewview>



**WARNING! THE SAUNA HEATER MUST NOT BE USED WITHOUT STONES. IF THE SPACE RESERVED FOR STONES IS NOT FULL, IT WILL CAUSE A FIRE HAZARD!**

**WARNING! BEFORE SWITCHING THE HEATER ON ALWAYS CHECK THAT THERE ISN'T ANYTHING ON TOP OF THE HEATER OR INSIDE THE GIVEN SAFETY DISTANCE**

# INSTALLATION AND USAGE OF LEGEND HEATER AND STEEL CHIMNEY

Harvia Legend -burning heater and steel chimney are delivered in a separate package (found inside the sauna). You will find more detailed instructions for use inside the package.

## BEFORE INSTALLING THE HEATER

BEFORE USING THE SAUNA AND PUTTING THE STONES INTO PLACE, A WOOD-BURNING SAUNA HEATER IS PREHEATED OUTDOORS ON A NON-COMBUSTIBLE BASE.

Before preheating, remove all protective plastic and stickers from the sauna heater. The purpose of preheating is to remove all protective agents from the sauna heater, such as harmful solvents and fumes released from the paint. Using the connecting pipe provided with the sauna heater in the top connection of the heater improves draught while preheating the stove. Filling the firebox with wood 1-2 times is enough for preheating. After heating, the material that has come loose from the space reserved for stones in the sauna heater is removed using a wire brush, for example. The painted outer surface of the sauna heater must not be scrubbed or wiped. Water must not be thrown on the sauna heater during preheating. Attach the sauna heater and add the stones in accordance with the instructions. You can find more information in the instructions of the sauna heater.



## Installing the flue

The sauna comes with a pre-dimensioned chimney suitable for the heater. The instructions for the chimney and the Kirami instructions differ slightly, as the chimney parts are pre-dimensioned for the sauna. The purpose of the steel flue is to lead the combustion gases coming from the fireplace safely outside. Install the flue precisely in the right place in accordance with the instructions below. In the image, you can see the parts of the flue and how to put them in place.

## Chimney fire

A chimney fire refers to the soot and combustion residue accumulated in the flue burning in an uncontrollable fire. A fire may be lit due to high heat, wind or a spark. You can avoid a chimney fire by ensuring that the flue is swept regularly and only burning dry wood with sufficient air in the fireplace.

If you detect a chimney fire in the flue, close the doors of the ash drawer and the firebox. A chimney sweeper must check the condition of the flue and the sauna heater after a chimney fire before next use.



THE EMERGENCY RESPONSE CENTRE MUST ALWAYS BE NOTIFIED ABOUT CHIMNEY FIRES (EVEN IF THEY HAVE BEEN EXTINGUISHED)!

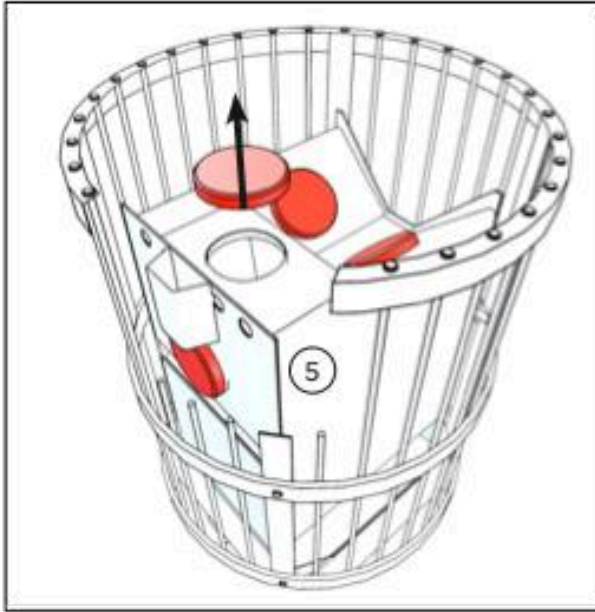

1. Legend heater has 4 chimney outlets. Check that the chimney outlet on top of the heater is free and the other three are blocked.

If necessary, move the protective cover.

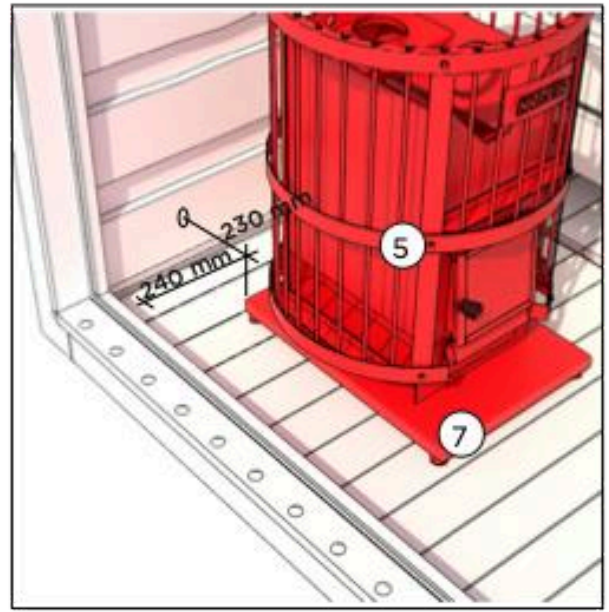

2. Place the Protective bedding on the floor according to the dimensions of the picture. Place heater on top of the Protective bedding.

The protective bedding and the heater have feet which can be adjusted to set the heater in a straight position using the spirit level.

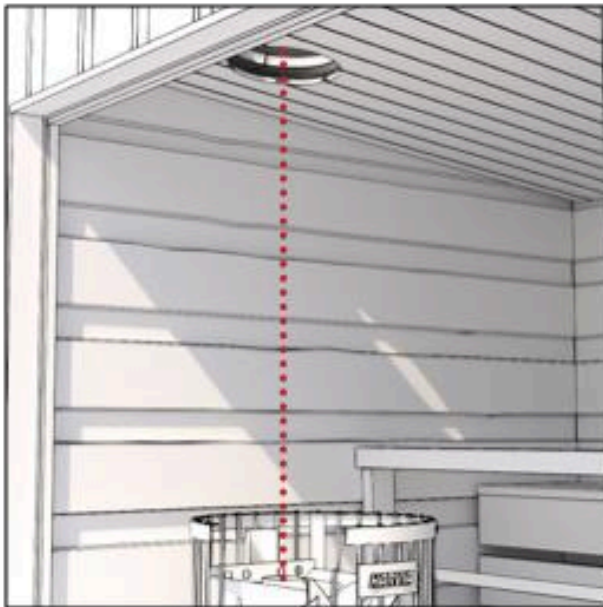

3. Visually check that the chimney outlet on the heater is in line with the hole in the roof.

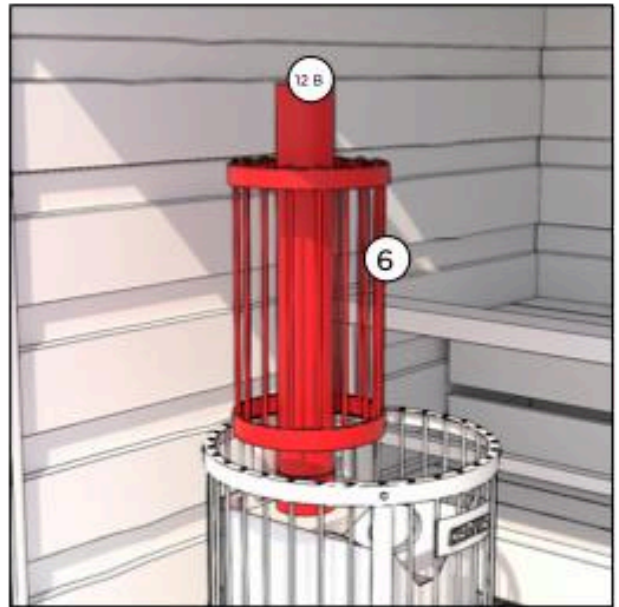

4. Install the smoke pipe in the outlet on top of the heater. Place the smoke pipe guard around the smoke pipe.

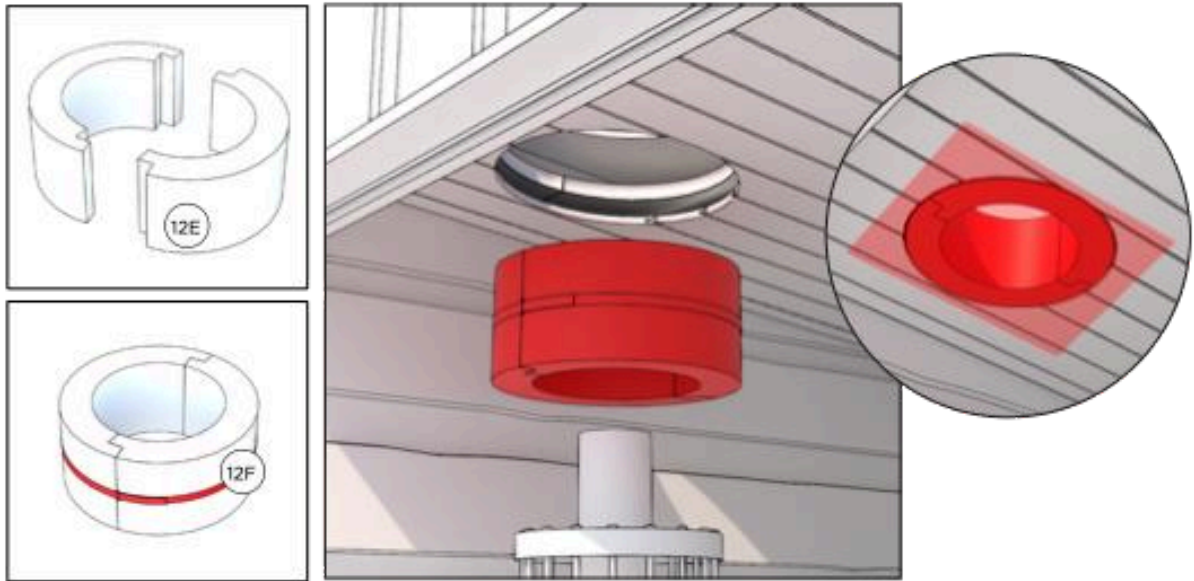

5. Take 2 pcs of insulation wool and fix them together using the clamp for insulation .

Insert the insulation into the roof from the inside so that the insulation is on the same level as the sauna ceiling.

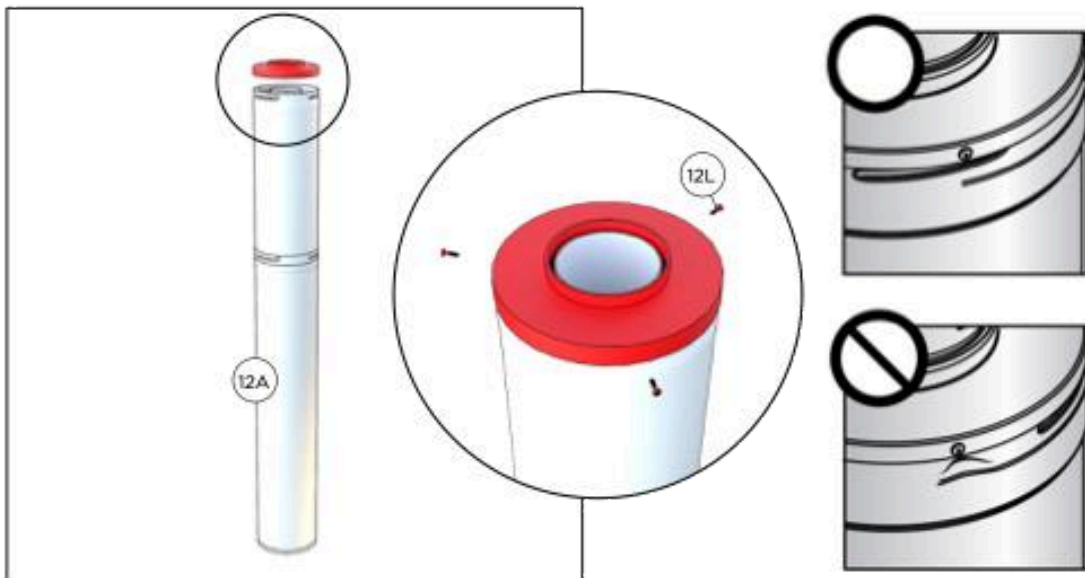

6. Attach the upper end to the steel pipe with three self-tapping screws. The screws are drilled through the plate.

NOTE! The upper end must be positioned so that the screws hit the grooves in the outer casing below.

### Finnish and Swedish models:

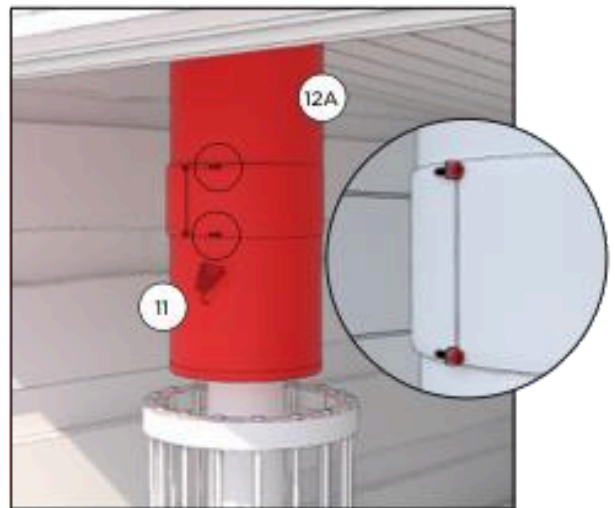
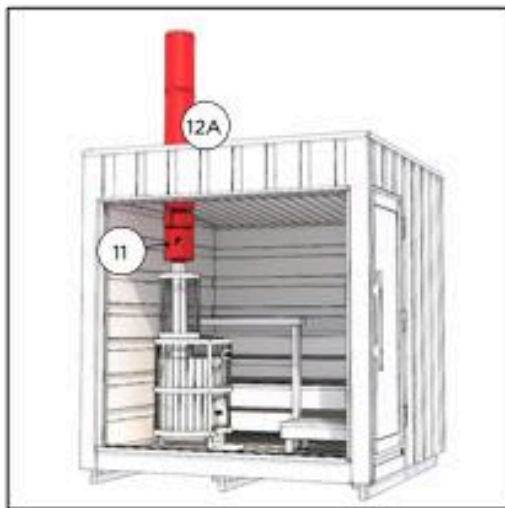

7A. Pass the steel pipe through the insulation wool and the roof.

Place the smoke damper section between the smoke pipe and the steel chimney pipe. Attach the smoke damper section and the steel pipe together using the clamp provided with the smoke damper section. The clamp is fastened with two screws.

### Other than Finland and Sweden:

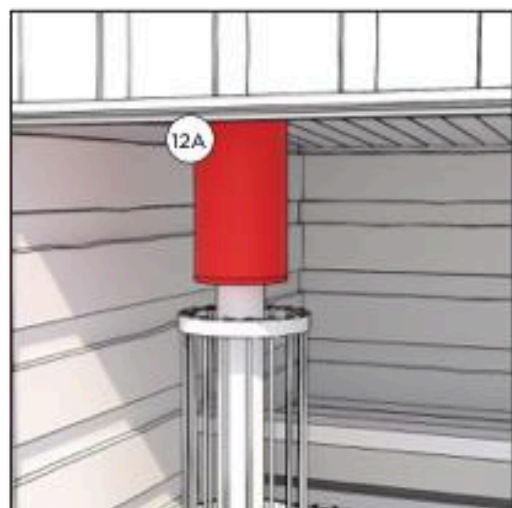
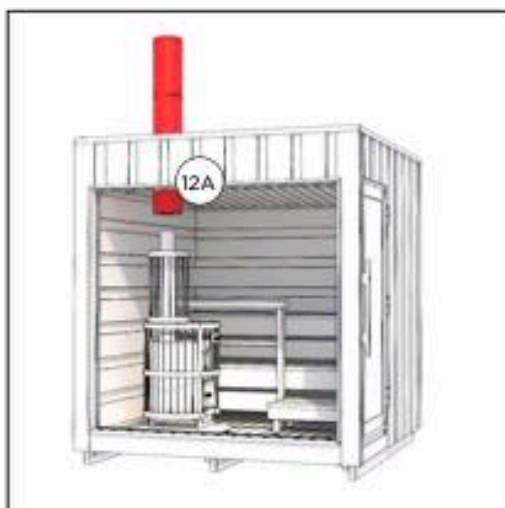

7B. Pass the steel pipe through the insulation wool and the roof. Place the steel pipe over the smoke pipe.

Always make sure the smoke damper is open before lighting a fire in the fireplace. It must not be closed until the charcoal has completely ceased to burn.

## Fire safety

If the sauna is located close to buildings or integrated into the terrace, you must ensure that the chimney is sufficiently removed from all flammable structures. You should remember to check the distance both in the vertical and horizontal direction to ensure there is no danger of ignition. Follow the instructions provided with the sauna heater. In addition, we recommend that you check the fire safety regulations of your residential area from the local fire or building authority. In Finland, the distance from the neighbour's border must be at least 4 m, unless the neighbour has given their written consent to build the structure closer. The distance between the sauna and the nearby buildings should be 8 m.

There must not be any flammable material in front of the sauna heater. There must be an area with non-combustible material (fireproof sheet), such as a metal sheet, in front of a wood-burning sauna heater.

When the sauna heater is heated for the first time after winter, the heating should be done carefully by only lighting a small fire to ensure that the firebox or flue of the sauna heater are not damaged. We recommend keeping fire extinguishing equipment close to the sauna. Ashes should be removed from the sauna heater regularly, preferably after each use. The fire grates last longer and draught remains good when the sauna heater is well cared for. Do not forget to empty the ashes into a non-combustible container and let them cool for approximately one day.

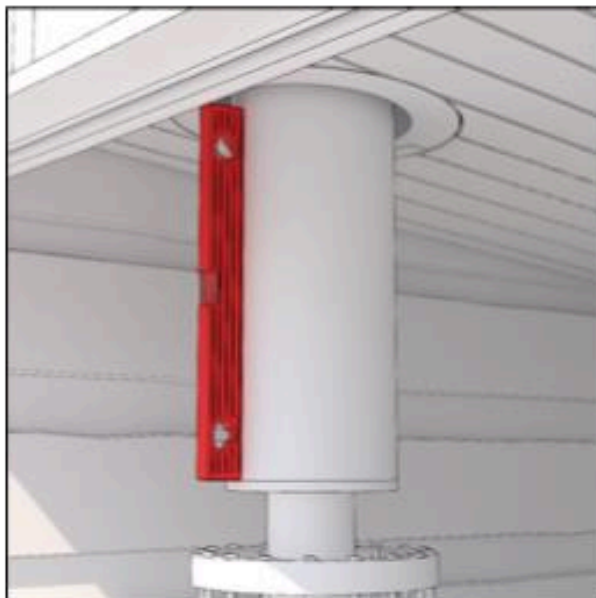

8. Check the straightness of the chimney. Move the heater if necessary.

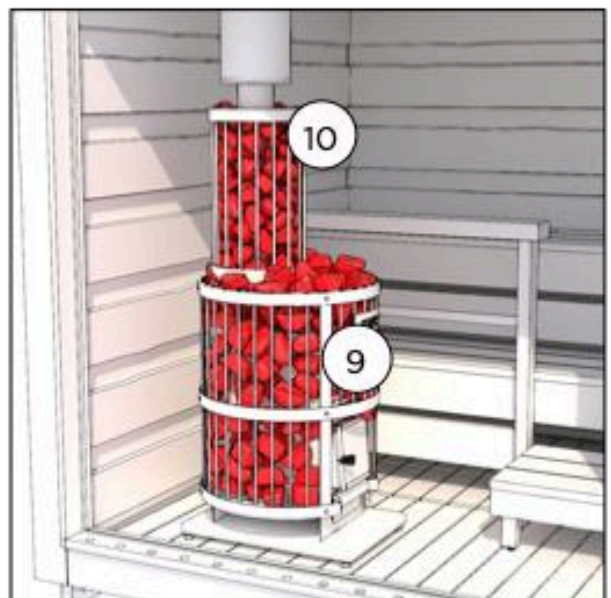

9. Put the stones in the heater. See the instructions supplied with the heater for more detailed instructions.

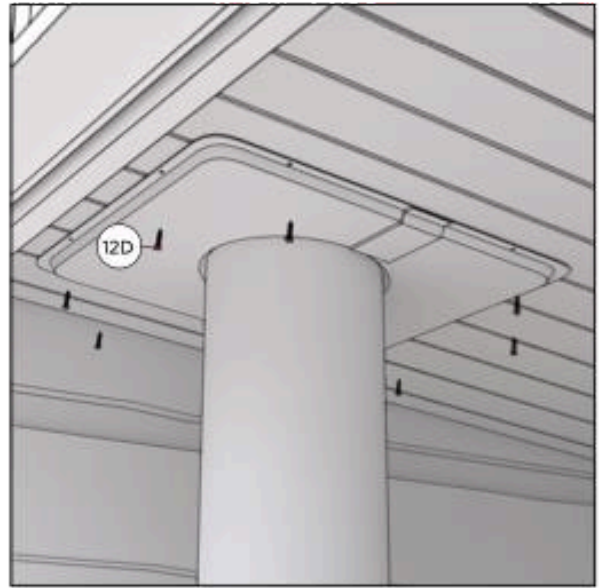
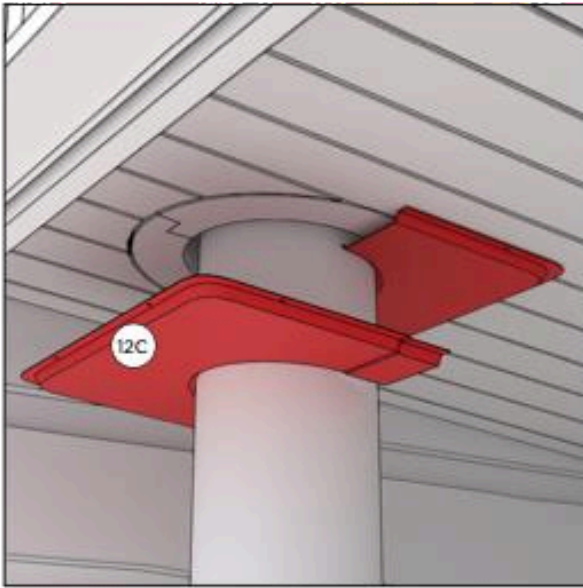

10. Attach 2 pcs of the lead-through flange to the ceiling of the sauna around the steel chimney. The components will overlap.

4 pcs 4,2x13 wronic screws are needed for each flange.

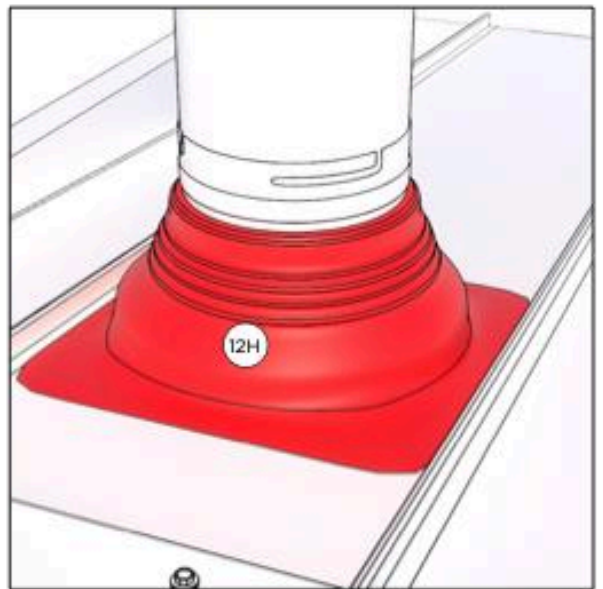
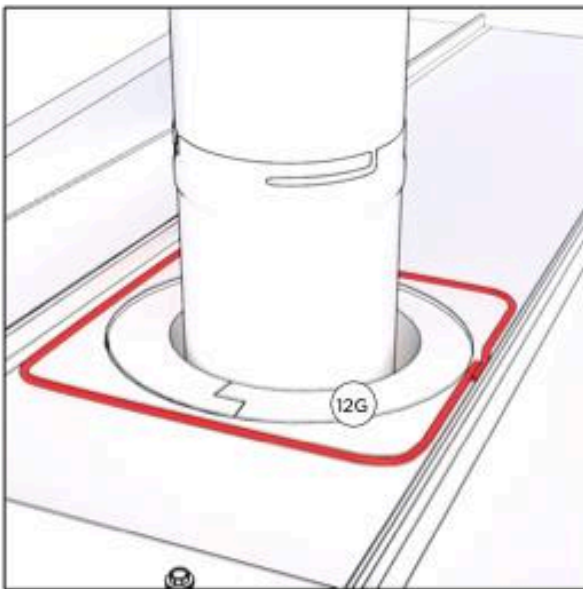

11. Put silicone on the tin roof around the hole. Slide the rain flange around the top of the chimney and carefully press it onto the silicone to attach it to the tin roof.

Smooth the excessive silicone against the edge of the flange.

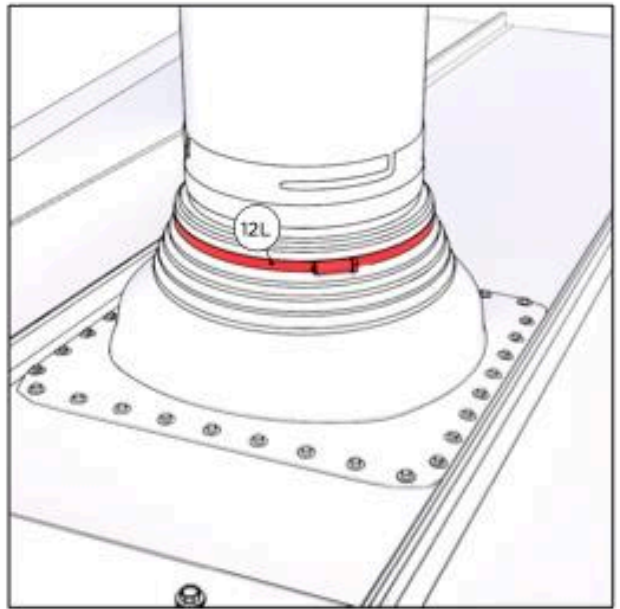
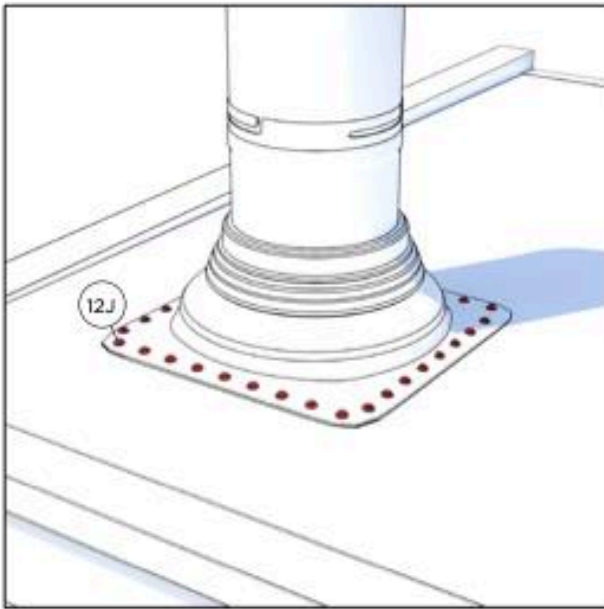

12. Fix the rain flange to the tin roof using the fixing screws. We recommend max. 35 mm spacing between them. Check that there are no gaps in the sealing.

Slide the clamp around the top of the chimney onto the top edge of the rain flange.

Tighten and lock the clamp firmly so that there are no gaps left in the top edge of the rain flange.



13. Lock the rain cap in place by turning it slightly clockwise.

**NOTE!** Do not tighten the rain cap too tightly. The rain cap must be removed during the cleaning of the chimney.

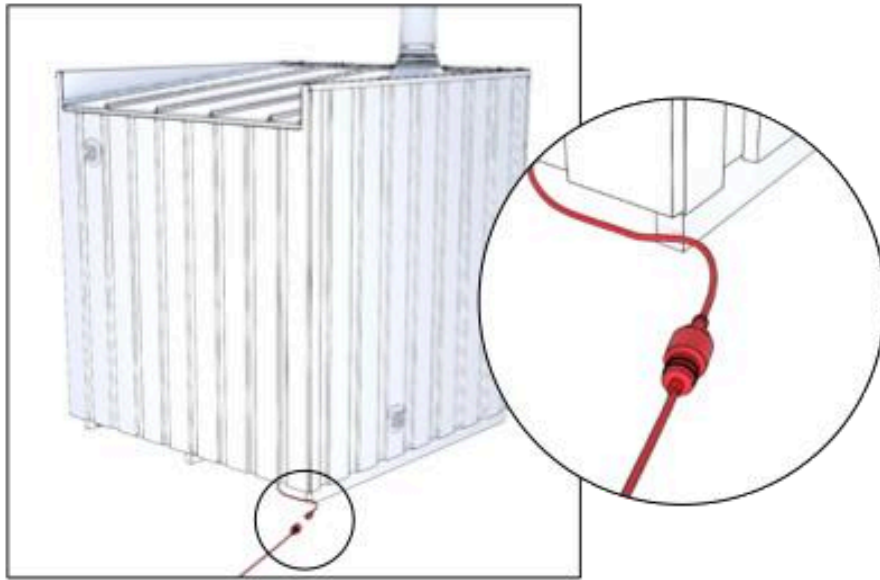

14. Connect the power to the sauna. The connection is located at the back of the sauna, on the stove side.

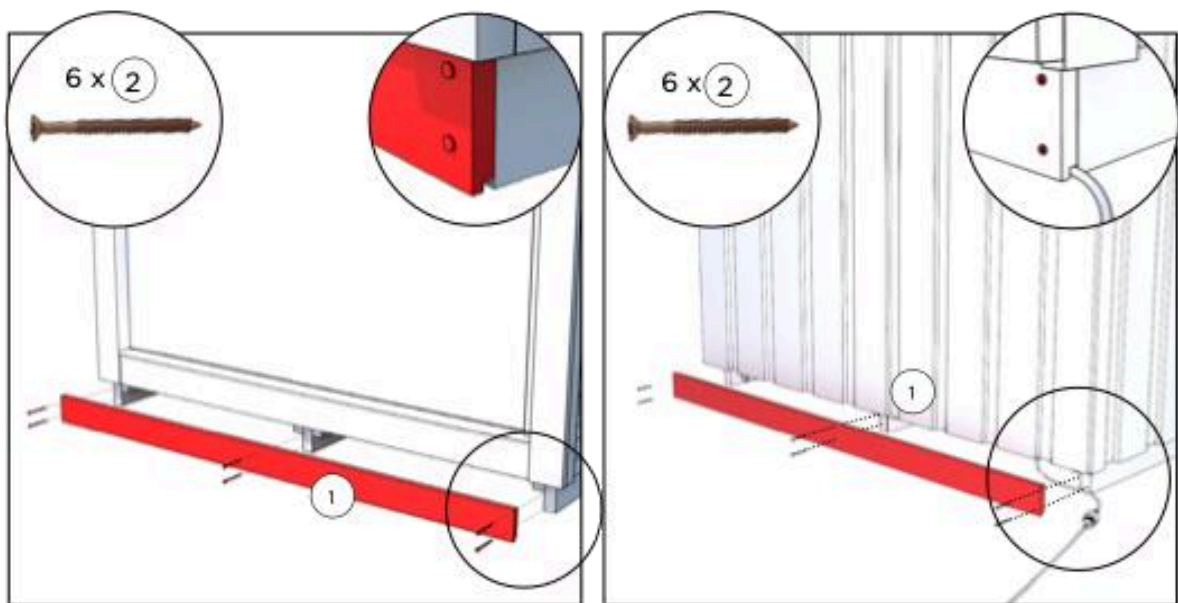

15. Finally, install the cover strips on the transport supports at the front and rear with the 6 brown terrace screws. Two screw per beam.

Position the cover strips so that the grooves in the strips face downward.

# HARVIA LEGEND - USAGE

## Lighting a fire in a wood-burning sauna heater

Only natural kindling and dry hardwood or softwood should be used for lighting a fire in a wood-burning sauna heater. The moisture content of the wood should be less than 20%. Good firewood consists of split wood with a diameter of around 5 cm, length of approx. 33 cm and weight approx. 0.5 kg. Stack the wood loosely into the firebox and light the fire from the top. A calm flame is a sign of suitable draft. You can adjust the amount of draft with the ash drawer. If the sauna heater makes a loud humming noise while heating, you should close the ash drawer more. When the flame is more even, the stones heat better and the flue does not get overheated. Low pressure may make lighting a fire in the firebox difficult; in that case, the sauna door can be held open for a moment and the ash drawer kept a bit further ajar until the firebox is properly lit.

Liquid fuel, cardboard or milk cartons must not be used for lighting fires. For lighting a fire, we recommend birch bark or firestarting blocks, such as Burner bags of paraffin.

The sauna door must be closed during heating. When the desired temperature (recommendation: 70–80 degrees Celsius) has been reached, a small fire can still be kept in the firebox to maintain the temperature of the sauna heater. Practice makes perfect in this as in anything else.

Empty the ashes from the sauna heater after each use to ensure that the fire grate/grates or air dampers are not covered by ash. Ash shortens their service life considerably. See detailed instructions on fire grates and their maintenance in the instructions of the sauna heater in question.

## Lighting

The end customer is responsible for connecting the sauna to electricity. If there is no need in the sauna for additional electricity for other reasons, such as an electric sauna heater, the electricity needed for the sauna lighting can also be provided with an approved electric cable reel. The light socket is ready for use and can be found under the sauna. You can power the lights by plugging them into the socket. The lights are always on when they are plugged in, there is no separate switch. The LED lights only consume a small amount of electricity, which means that mood lighting can be on even if the sauna is not in use.

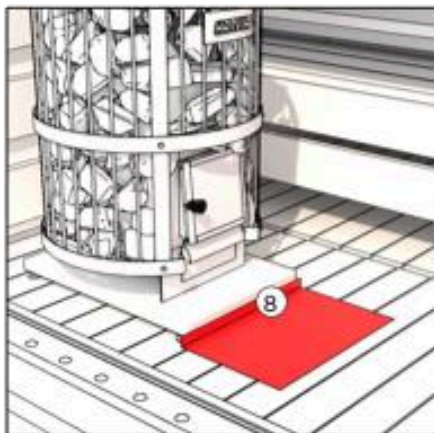

There must not be any flammable material in front of the sauna heater. There must be an area with non-combustible material (fireproof sheet is delivered with the sauna)

# GENERAL

## Preheating before using the sauna

Before the first heating, it is a good to wipe the dust off the sauna with a moist cloth or spray water with a garden hose, for example (Make sure that the sauna dries properly if you don't use it after washing).

If you use detergents, use environmentally friendly and sauna-friendly substances, such as Kirami Biopesu. Also check that there are enough stones in the heater according to the instructions and that the hearth plate is in place and that there is nothing flammable near the stove (eg textiles must not be dried on or in the immediate vicinity of the heater). Always remember to guard the heater and keep small children or animals away from the heated heater alone.

## Sauna bathing

The most important thing while sauna bathing is to take care of hydration, i.e. drinking water. Even though sauna bathing is beneficial to your health, you must always listen to your body. Suitable heat and steam in the sauna is a combination of the right temperature, humidity and ventilation. In Finland, sauna bathing at a temperature of 70-80 degrees Celsius is normal. The heat should nevertheless reach at least 70 degrees to kill any possible bacteria.

Avoid sauna bathing with babies less than six months old, because their heat tolerance has not developed yet. You can start taking babies of six months of age or older to the sauna for short periods of time while staying on the lowest benches and not throwing water on the rocks. If you have an illness, always ask the doctor for recommendations on sauna bathing.

Please note that the sauna heater and its parts get hot when the heater is heated. Always use protective gloves when touching parts of the heater. Move carefully in the sauna, because the floor and benches of the sauna may be slippery

## Recommended accessories

We recommend the following accessories to make sauna bathing an easy and enjoyable experience. Water bucket and ladle are necessary: they can be used to throw a suitable amount of water on the sauna heater. Thermometer makes it easy to monitor the temperature both while heating up the sauna as well as maintaining the heat. Sauna bench towels make it easy to maintain hygiene; the benches do not feel hot and the towels decorate the sauna beautifully. Different kinds of sauna scents create a complete sauna experiences for the senses; e.g. the eucalyptus sauna scent opens up your nose if you have a cold (always remember to read the instructions on the sauna scent package).

We recommend using organic sauna scents. They are environmentally friendly. Sauna and bathing hats protect the bathers from cold, especially while cooling off outside in cold weather. In Finland, we also use a sauna whisk during the summer. The sauna whisk is bound out of birch twigs, and we Finns use it to gently whip ourselves. Using the whisk improves the circulation of blood in the body.**Sauna and hot tub - best friends forever!**

In Finland, saunas and tubs are best friends forever: where there's a tub, there's a sau-

na. It feels great to step outside to the yard from the heat of the sauna to cool off and plunge into the even temperature of the hot tub to relax. The hot tub itself is a pleasure, crowned by bathing in the sauna. Inside the sauna, you can enjoy the quiet only broken by the hissing of the sauna heater, while in the hot tub you can listen to the sounds of the surrounding nature.

## SAUNA CARE AND SAFETY

### **Replacing the sauna heater stones**

Maintenance is a part of the normal use of the sauna heater. The stones should be replaced regularly to ensure that the sauna heater operates well and flawlessly. The stones disintegrate slowly under the thermal stress. The stones do not need to be replaced every year, but they should be restacked. In the sauna, we have used traditional Harvia sauna heater stones.

### **The characteristics of wood and surface treatment**

Wood is a natural material, and you should know the following about its characteristics. Normally, wooden materials gain a grey tint in roughly one year, depending on the amount of sunlight (care instructions below). Sometimes resin may be exuded from knots, but it can be removed from the knots with a steel trowel and the area treated with knotting solution. Splinters may also come off from the wood; they should be removed immediately using a sterile needle (use e.g. wound cleaner to disinfect it).

### **Surfaces of the sauna**

The surfaces of the sauna, made with plain sawn softwood and spruce plywood, has a beautiful black tint. If you want to maintain this shade of black, the outside of the sauna must be stained every few years, depending on how the sauna is used. At the factory, the sauna is treated with industrial water-based wood oil. If you want to use the original industrial wood oil to treat the sauna again, you can order the wood oil via your retailer.

### **Hygiene**

We always recommend washing up before and after sauna bathing. Always use clean sauna bench towels to protect the benches and maintain hygiene. A clean sauna has a fresh scent, which makes sauna bathing a pleasure.

### **Cleaning**

Ensure the cleanliness and hygiene of the sauna by washing it sufficiently often. Before washing the sauna, empty the ashes from the sauna heater's firebox and brush off all rubbish from the floor. We recommend using environmentally friendly cleaning agents such as Kirami's Biowash for washing the sauna. Rinse the sauna walls, benches and floor well after washing; you can also use a garden hose to spray water on the surfaces in question.

### **Other safety issues**

Ensure the safety of children in the sauna and in its vicinity. Children must not be left unsupervised in the sauna. When the sauna is not in use, its door should be kept closed and locked, if necessary.

Do not overheat the sauna. The recommended sauna temperature is 70–80°C. When going to the sauna while it is cold outside, you should use a bathing hat while cooling off outside to avoid catching a cold.

Avoid using the sauna if you are tired or feeling unwell. Sauna bathing for long periods of time may cause dehydration, and in the worst case scenario, bathing in an excessively hot sauna may cause a heatstroke.

If you have an illness, always ask the doctor for recommendations on sauna bathing.

## WARRANTY

We give our sauna a warranty of 24 months concerning material and manufacturing defects.

The warranty is valid when the user has studied the product's instruction manual and complies with it.

NOTE! An exception to the above is the warranty period of 6 months given to products used for commercial purposes.

- The warranty does not cover any defects typical to wood materials that may occur. E.g. colour changes, changes in humidity, cracks forming, and similar issues.
- The warranty does not cover wear and tear due to normal use.
- The warranty does not cover damage due to user error, for example.
- The warranty does not cover frost damage, either, because it can be avoided with correct use.
- The warranty does not cover any corrosion due to the use of wrong cleaning agents.
- The warranty does not cover any indirect costs, such as building or demolishing a terrace.

Contact the seller of the product immediately regarding issues with warranties. Attempting to repair the product yourself voids the warranty.

## DISPOSING OF THE PRODUCT

The metal parts of the product should be taken to metal recycling, while the wooden parts can be burned, and the glass can be taken to a glass recycling point. The other parts should be disposed of with mixed waste. In Finland, used LED lights can be returned for free and without an obligation to buy a new product to shops where lamps are a part of the usual selection, or alternatively they can be taken to a recycling point.

### HARVIA LEGEND PRO PO11 (*Rate Outdoors model - Brenner*)

<https://mediabank.harvia.com/catalog/Harvia/r/918/viewmode=previewview>



### CONTROL PANEL

<https://mediabank.harvia.com/catalog/Harvia/r/6228/viewmode=previewview>



### HARVIA LEGEND240 (*Rate Outdoors model - Brenner*)

<https://mediabank.harvia.com/catalog/Harvia/r/3479/viewmode=previewview>





***ENJOY YOUR SAUNA!***

*Manufactured by:*

