



## INSTALLATION INSTRUCTIONS

### The Harvia Ventura Sauna

*Read these instructions to guide your assembly.  
Check the contents of delivery without delay!  
Study the instructions and keep for future reference.*



*Manufactured By:*



Table of contents VENTURA-sauna cabin

Sauna cabin		
Wall-elements	Info	Quantity
A1		1 pc
A2		1 pc
B1		1 pc
B2		1 pc
C1		1 pc
C2		1 pc
Back steel profiles		
Back profile L (LEFT)	ZVEL-720	1 pc
Back profile R (RIGHT)	ZVEL-721	1 pc
Roof element(s)		
R1		1 pc
R2	if depth bigger than 1200mm	1 pc
Front steel profile		
Front profile L (LEFT)	ZVEL-730	1 pc
Front profile R (RIGHT)	ZVEL-731	1 pc
Back corner covers		
Left back corner cover		1 pc
Right back corner cover		1 pc
Corner trims		2 pcs
Benches		
Lower bench 1		1 pc
Lower bench 2	layout dependent	1 pc
Upper bench 1		1 pc
Upper bench 2	layout dependent	1 pc
Upper bench 3	layout dependent	1 pc
Bench support(s)		
Standard bench support(s)	layout dependent	
Back rest(s)		
Back rest 1		1 pc
Back rest 2	layout dependent	1 pc
Back rest 3	layout dependent	1 pc
Glass front		
G1	Next to door with hinges	1 pc
G2	Next to door	1 pc
D	Door glass	1 pc
UG	Upper glass above the door	1 pc
Hinges	SAZ0602 (RG-932)	2 pcs
Door handle	SAZ045, chrome	1 pc
Threaded rod	KT021	1 pc
Magnet holder	ZVEL-500	1 pc
Counter part for magnets	ZVEL-501	1 pc
Magnet	SAZ048KPL	1 pc
Glass supporting leg	SAZ064M	4 pcs
LIGHTING		
Sauna lamp white	SAS21060T	1 pc
RGBW-LED tubes	layout dependent	4 pcs
Power 90W (24V)	layout dependent	1 pc
Power 180W (24V)	layout dependent	1 pc
RGBW LED funk driver CV 24V		1 pc
RGBW LED remote unit 1 zone		1 pc
Ventilation		
Ventilation tunnel, steel	ZVEL-740	1 pc
AIR Ventilation slider, black	4021101	1 pc
Accessories		
Installation instructions		1 pc
Screws	layout dependent	

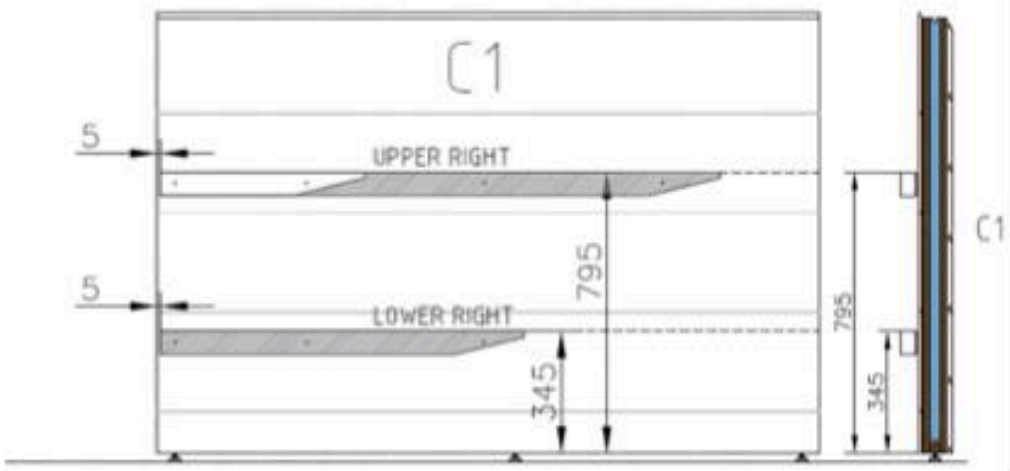
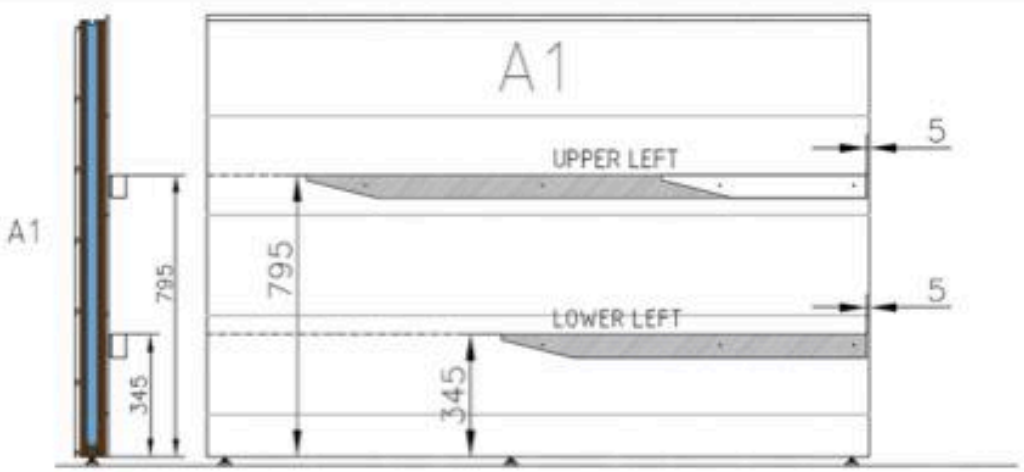
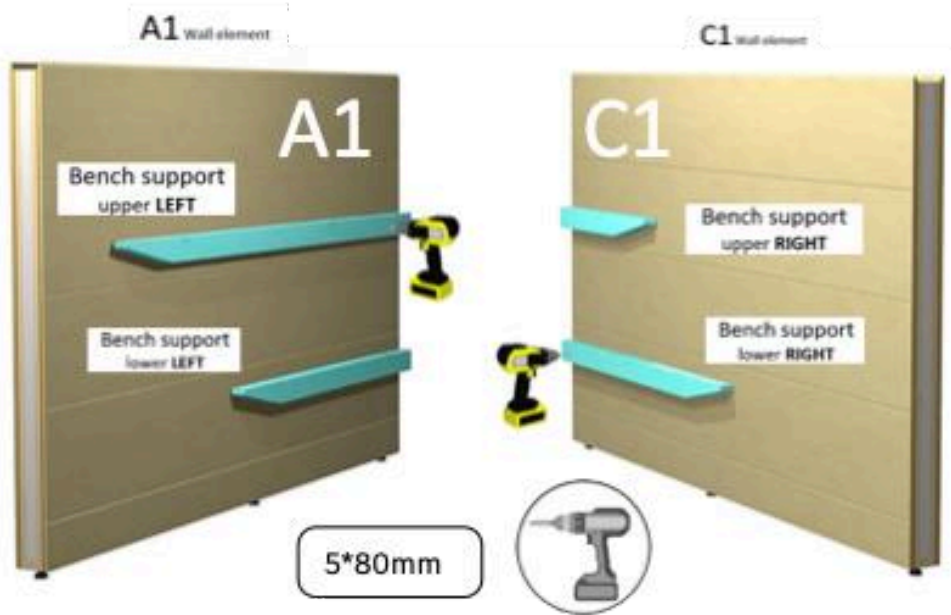



L = LEFT



A1

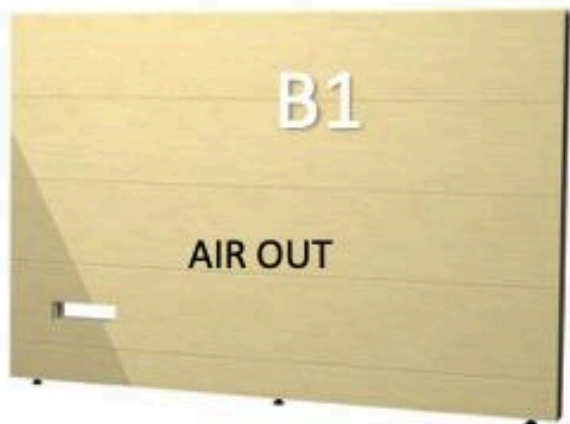

B1

AIR OUT



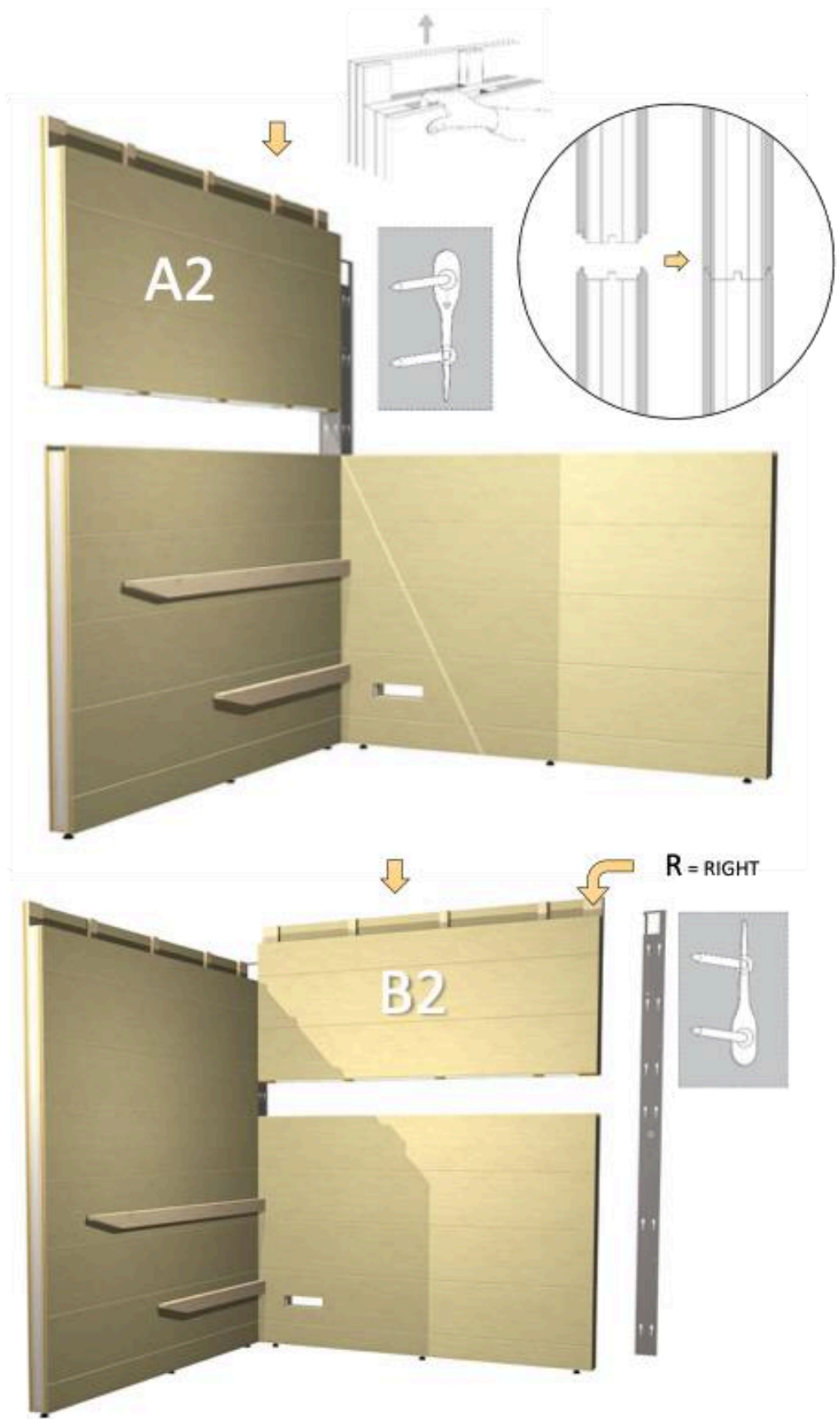

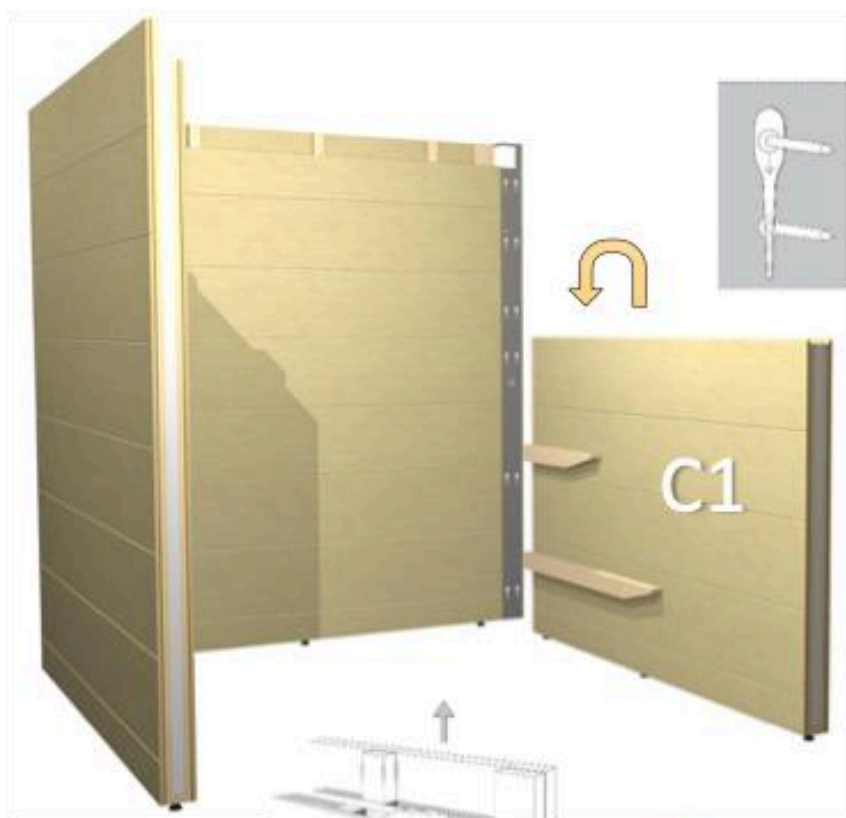

R = Roof

R1 ↓

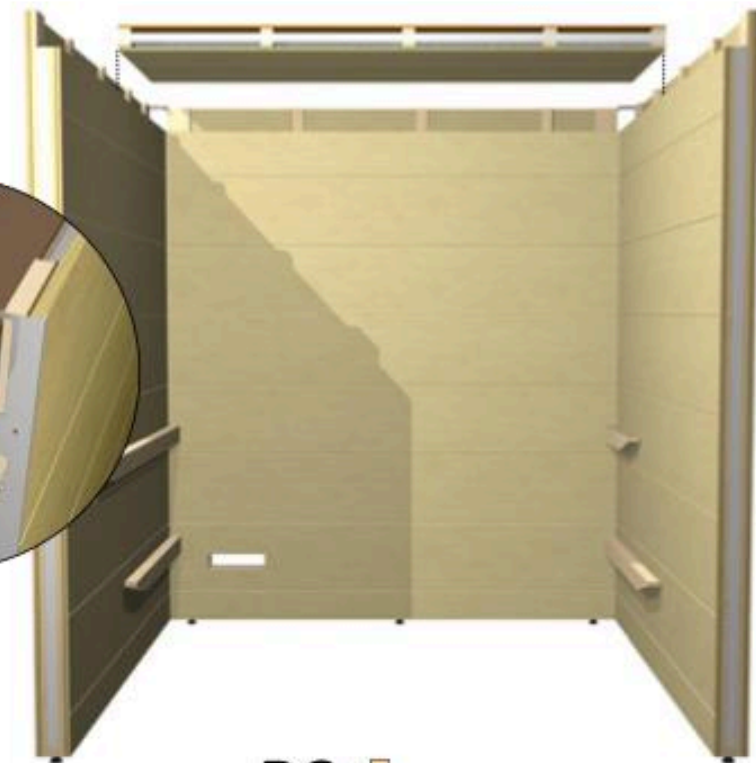
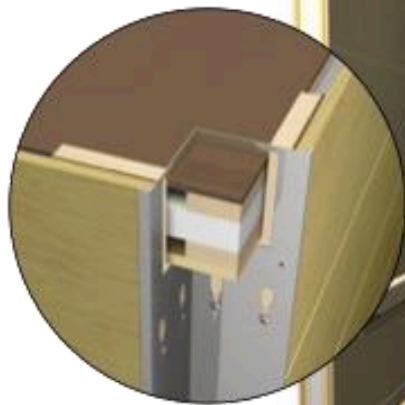

R2 ↓

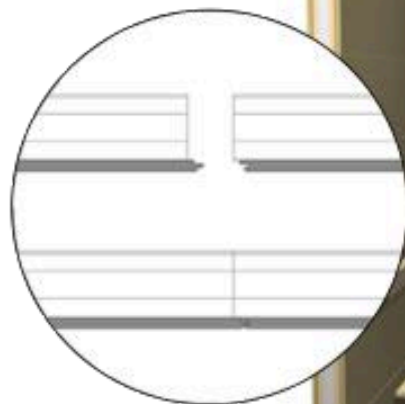
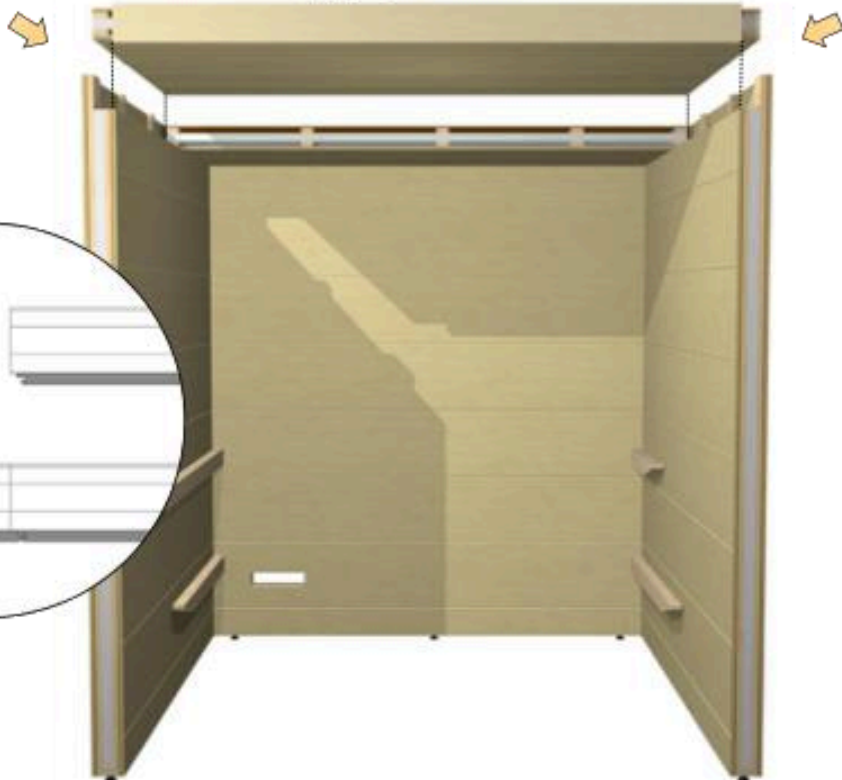

L = LEFT

R = RIGHT

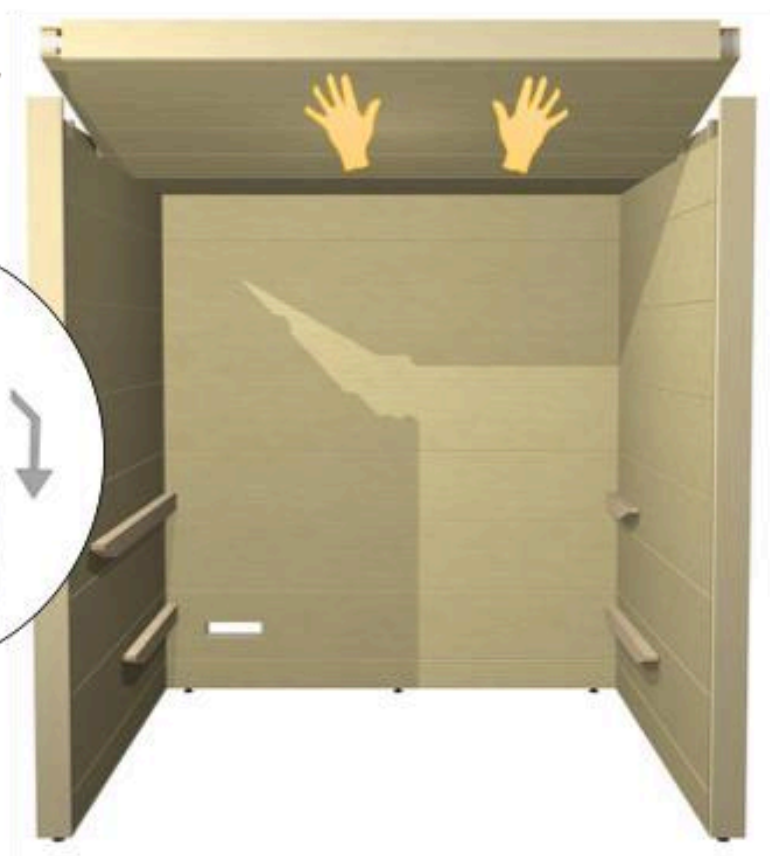
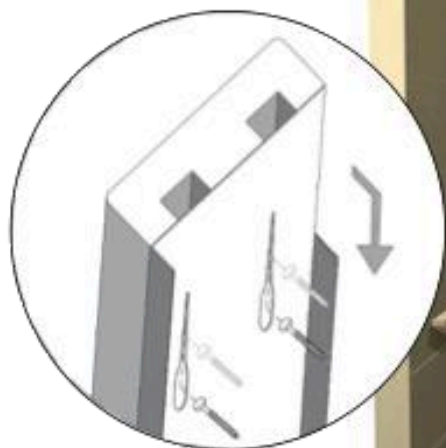

4,5\*60mm

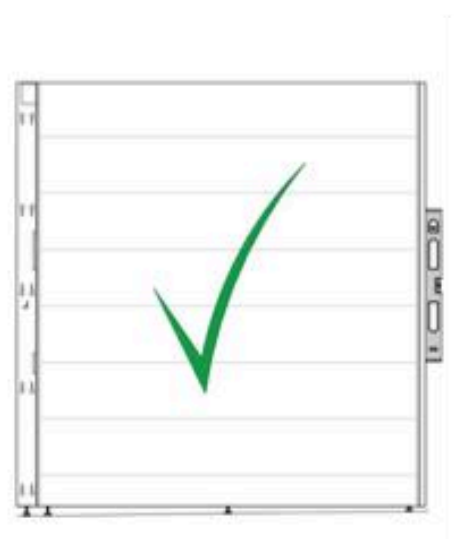
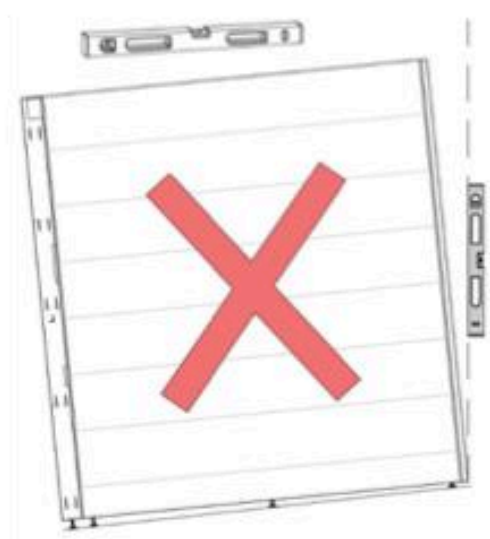
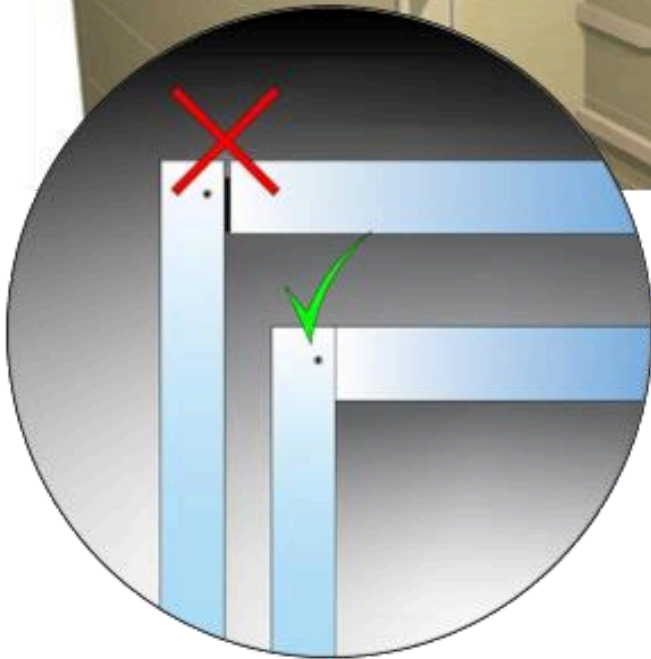
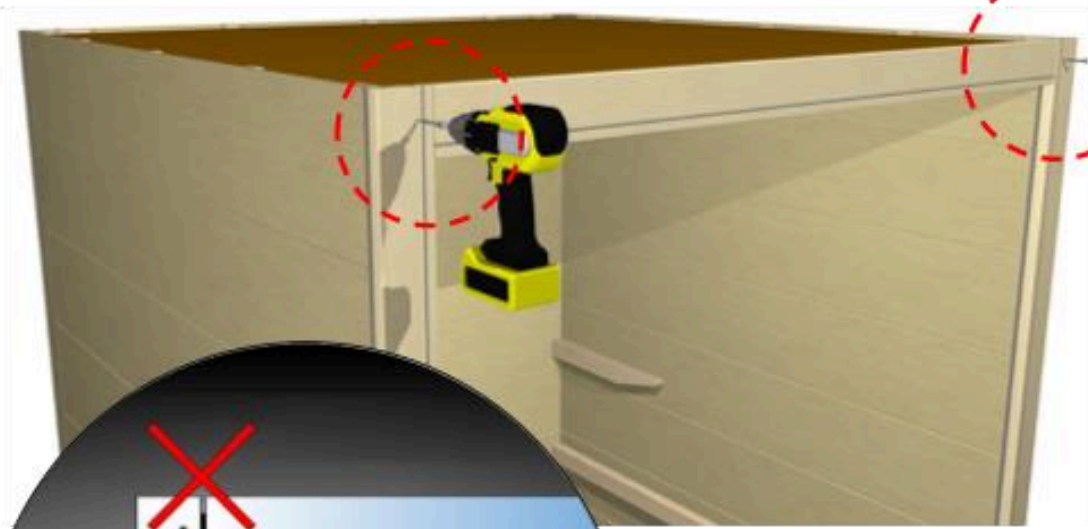

# AIR OUT

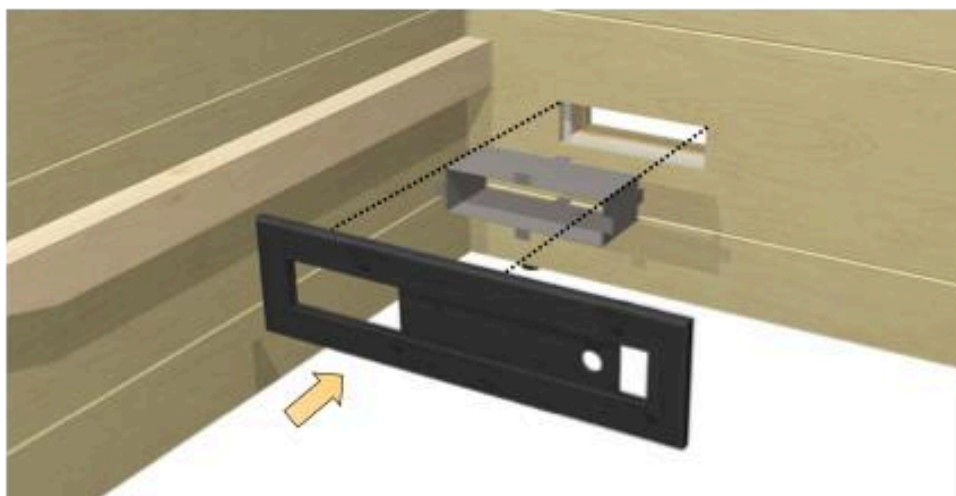

ZVEL-740

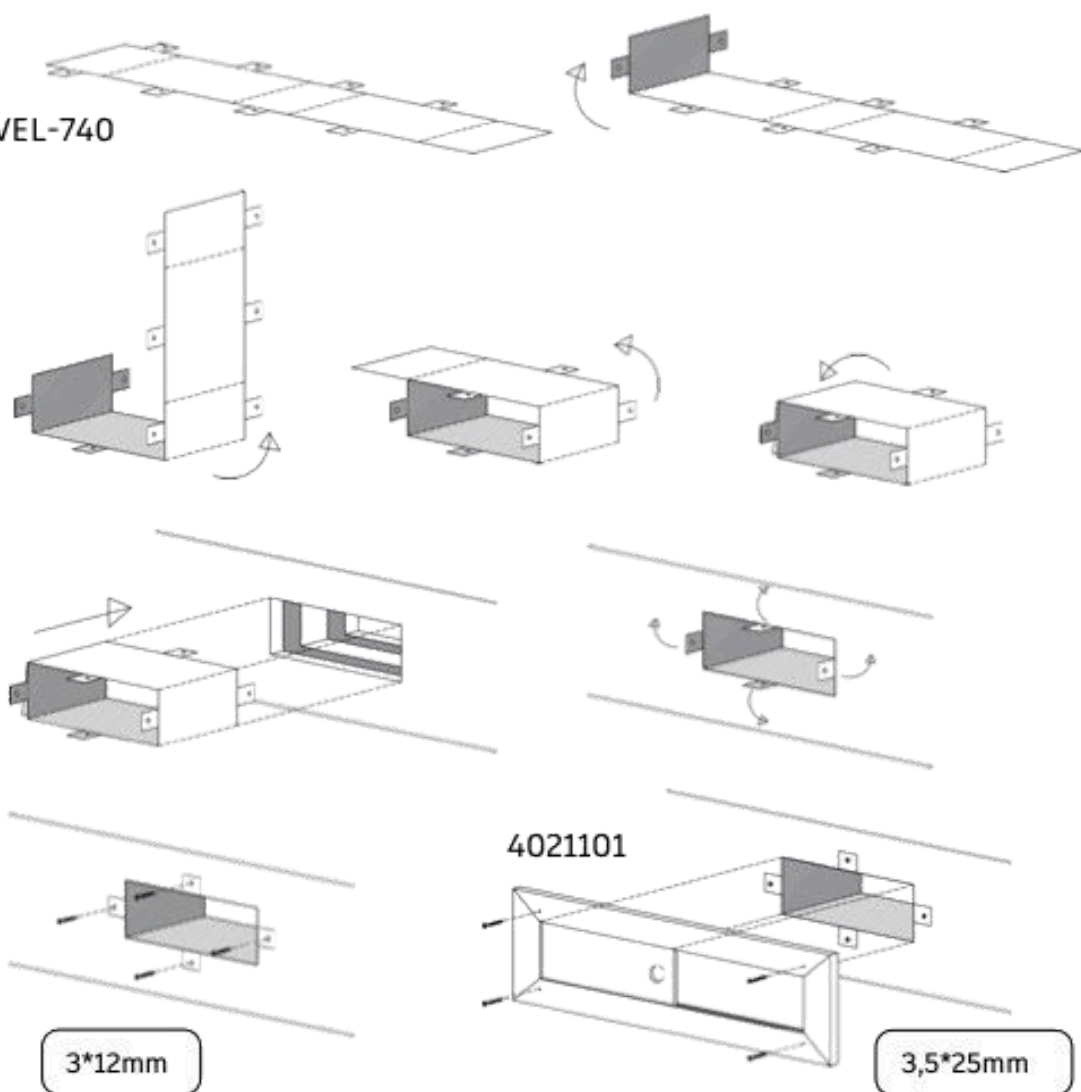

## BENCHES

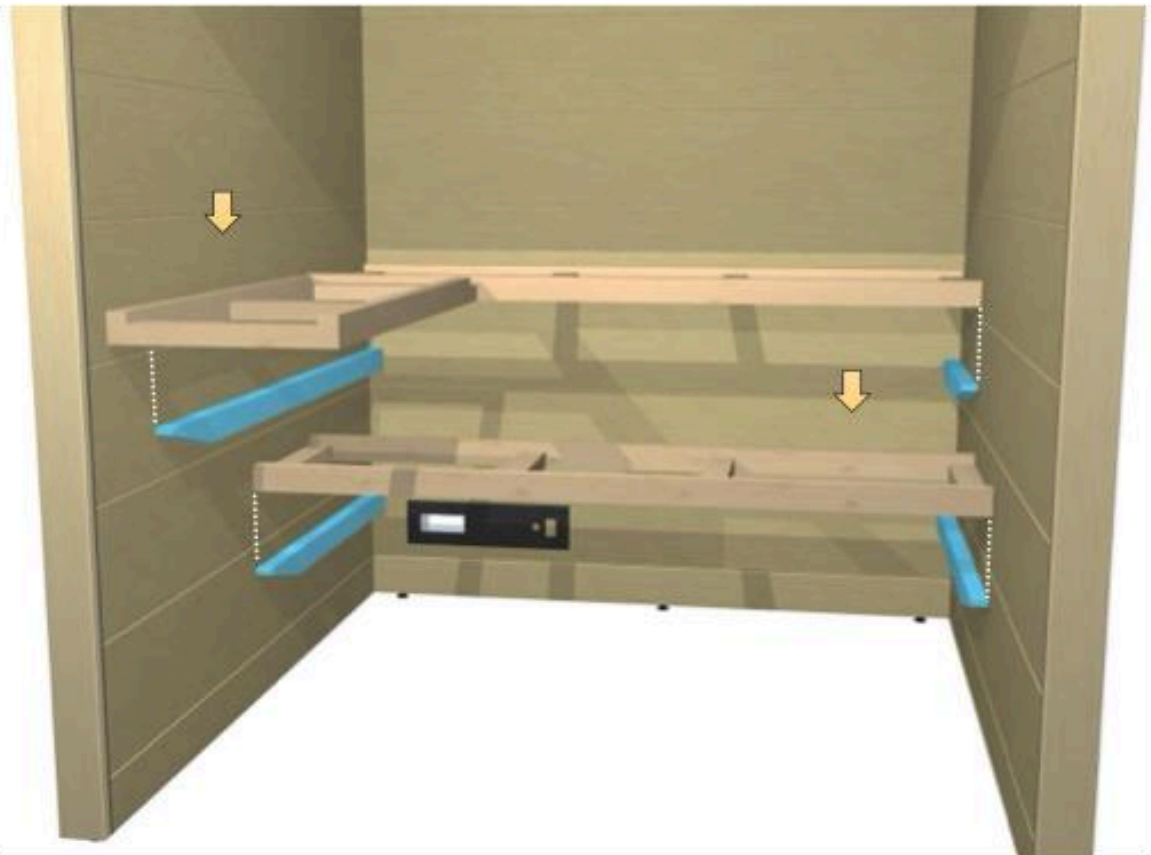
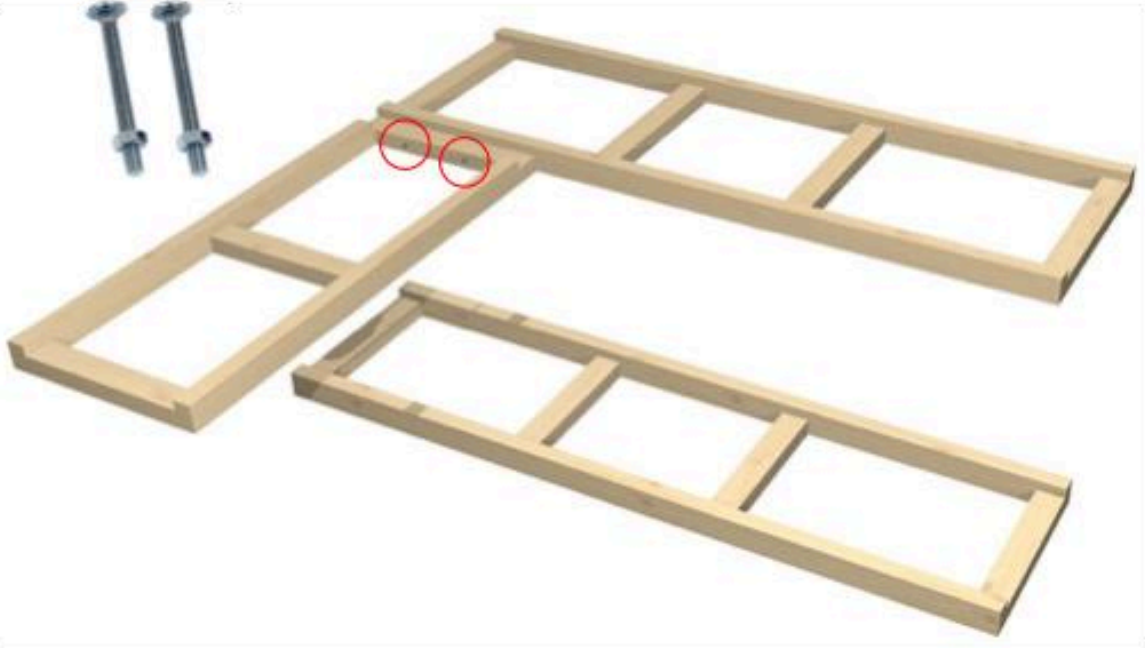

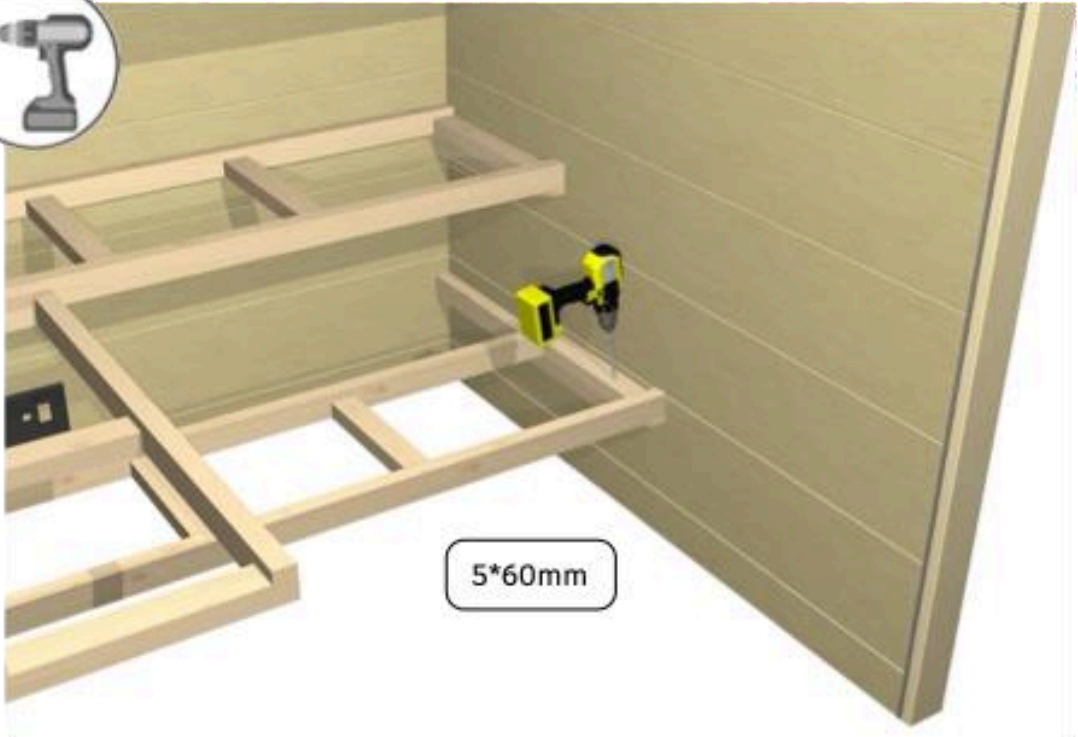

5\*60mm

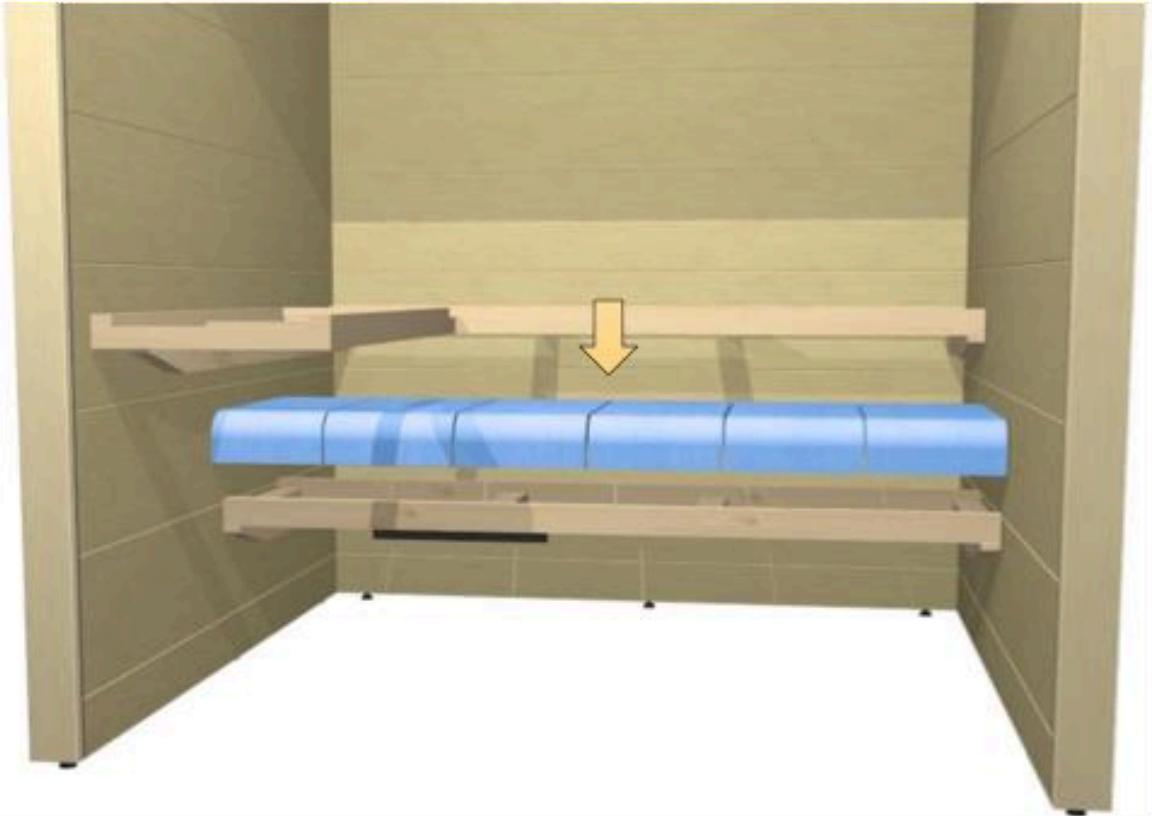

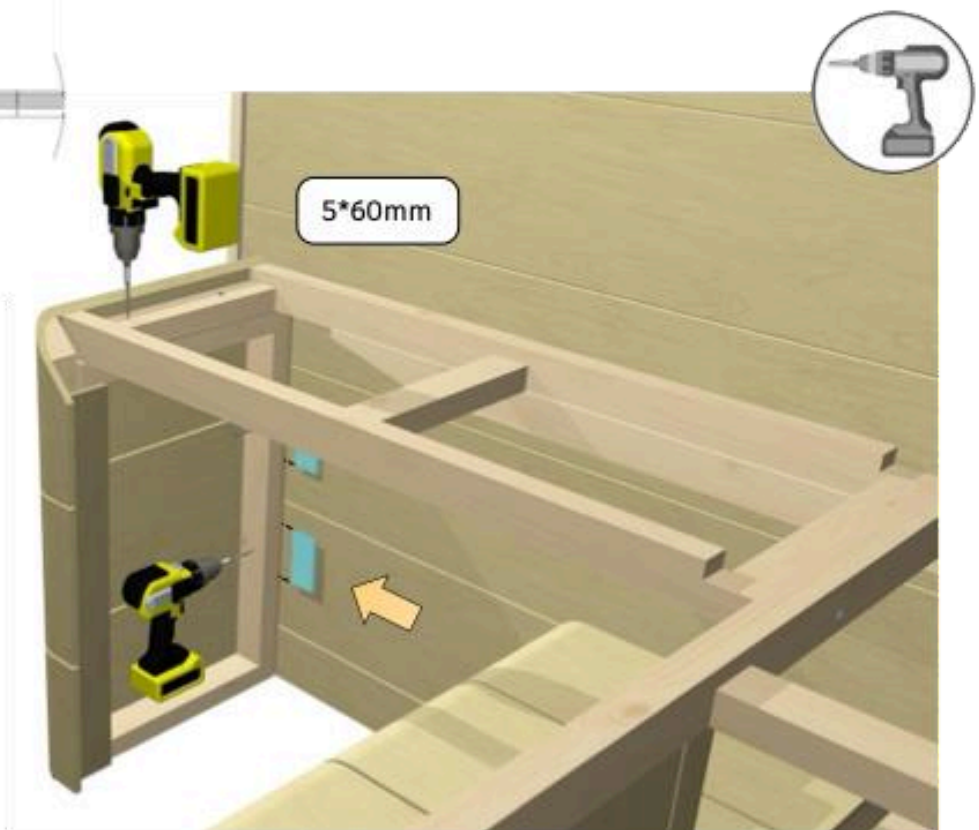

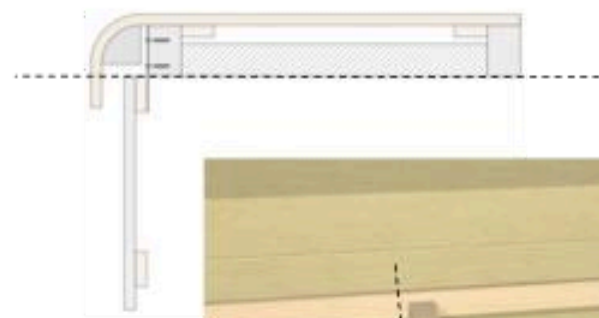

3,5\*25mm

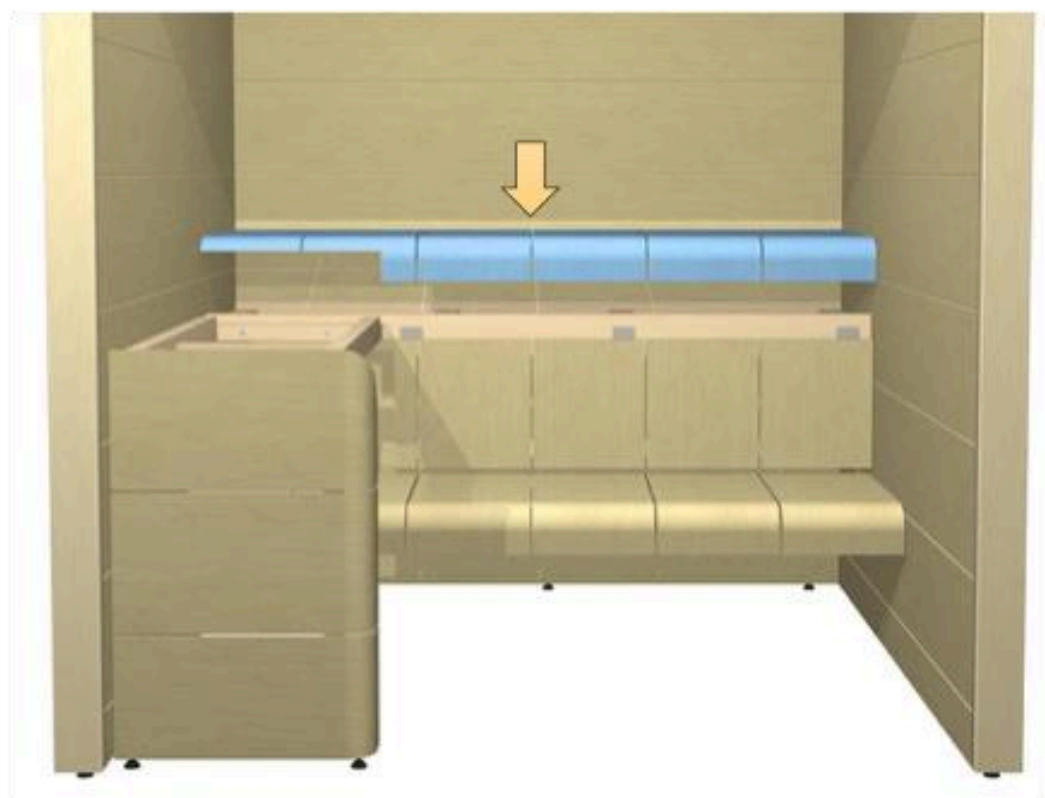
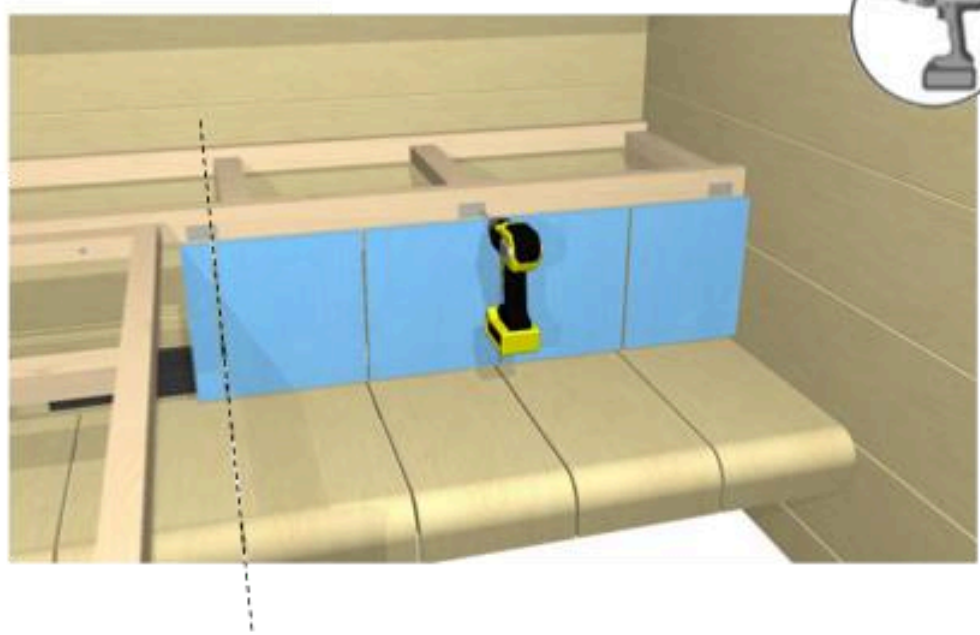

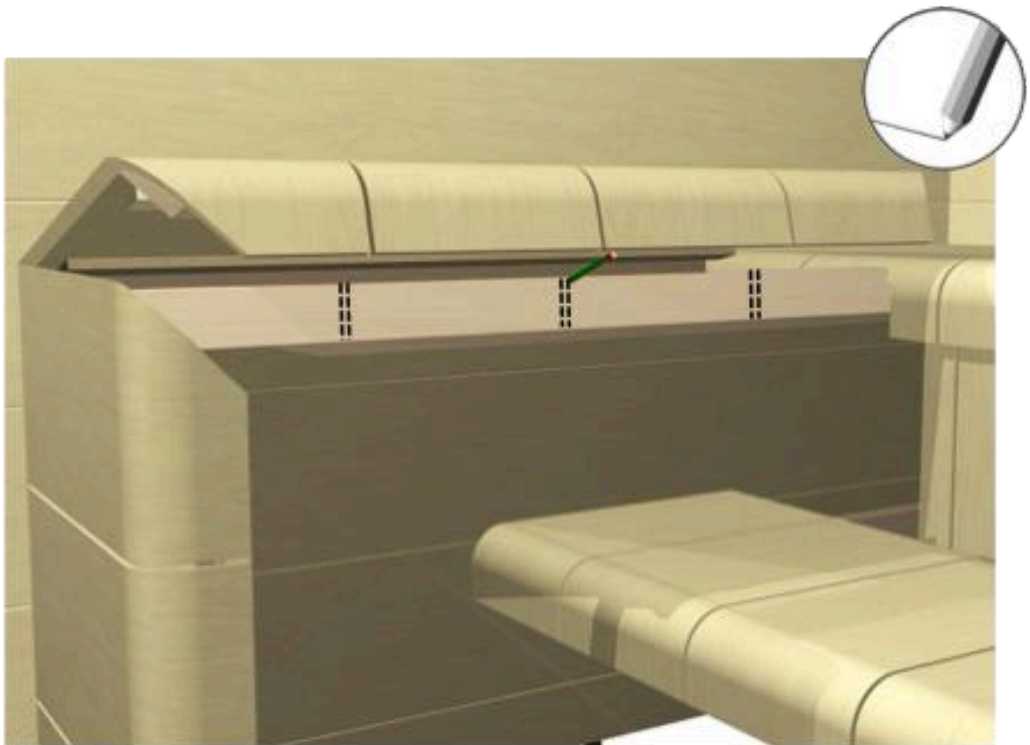
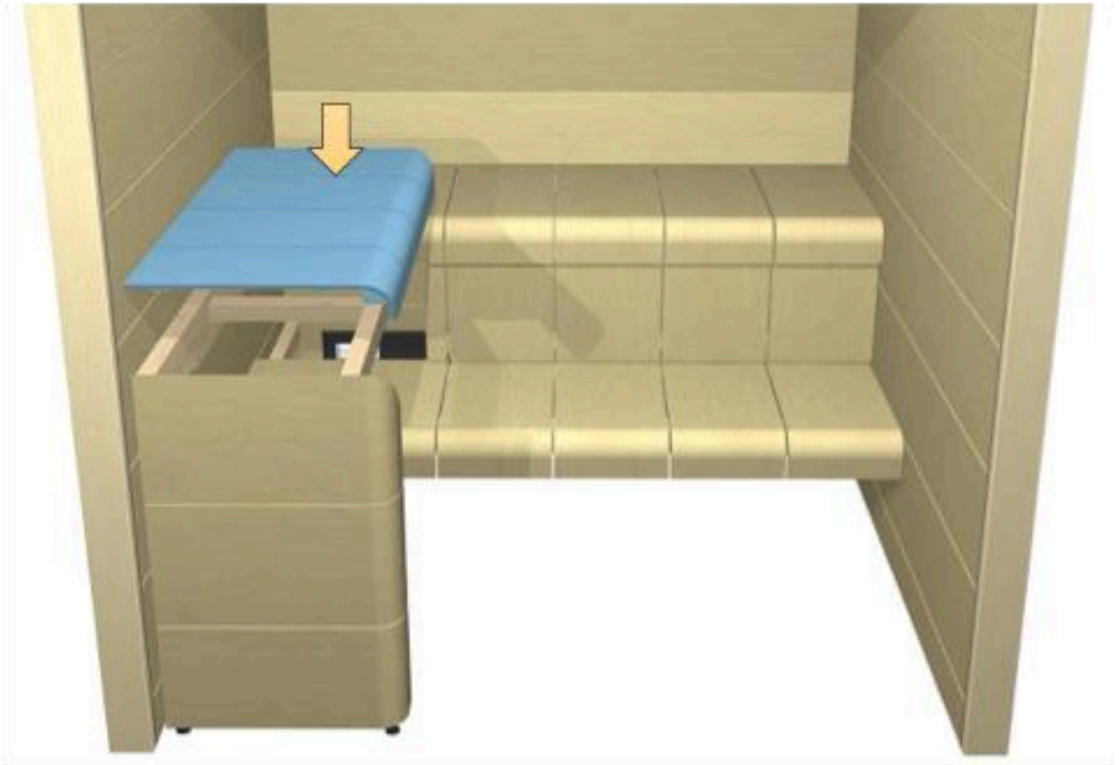



3,5\*25mm

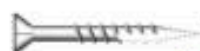
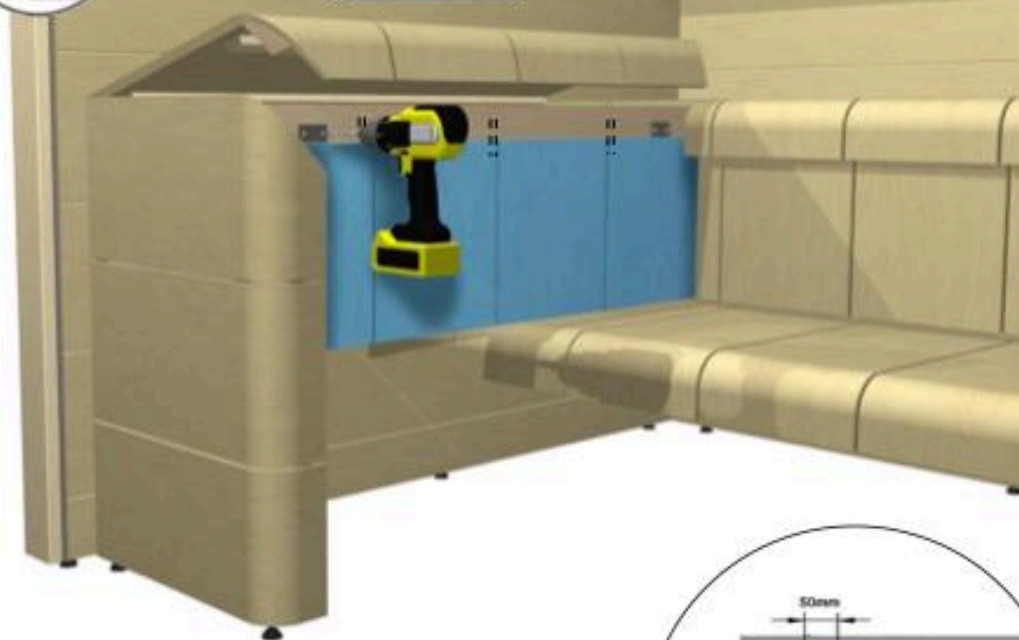

4,2\*55mm

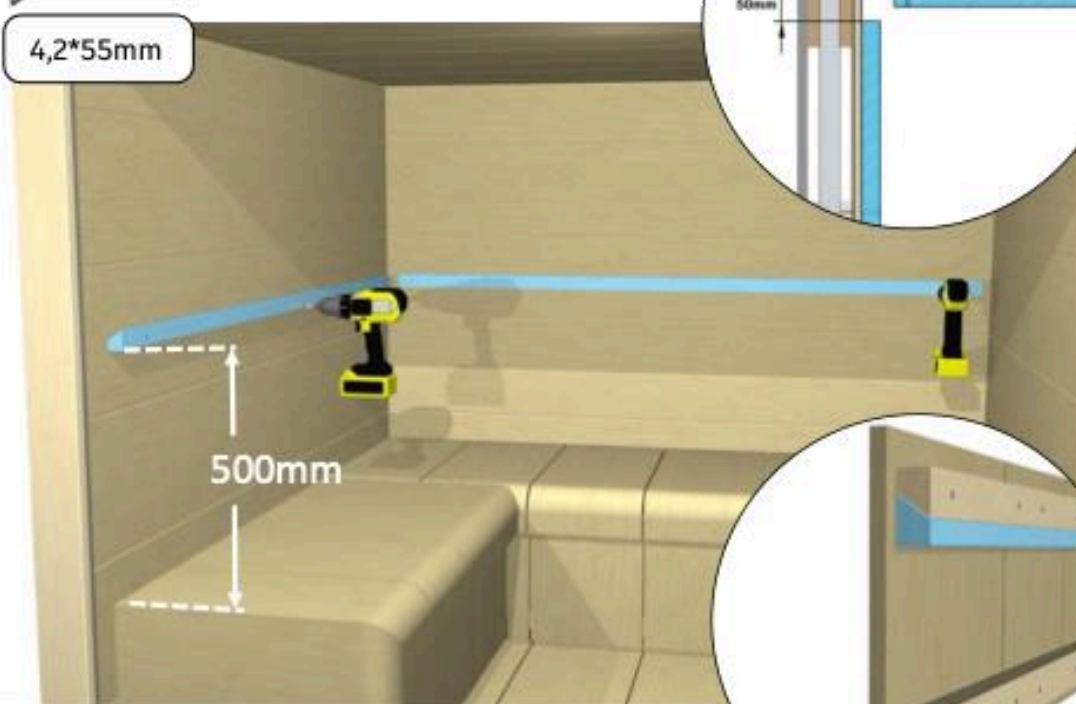

# LED LIGHTS

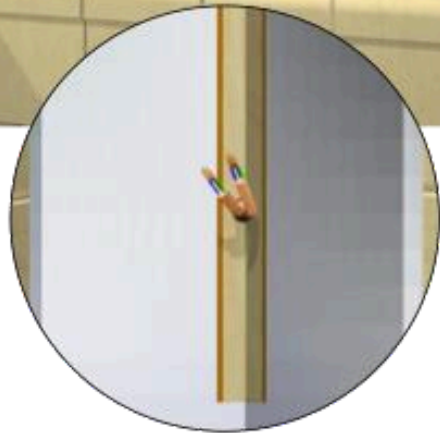
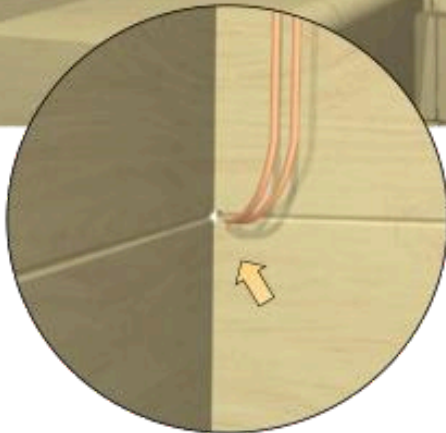
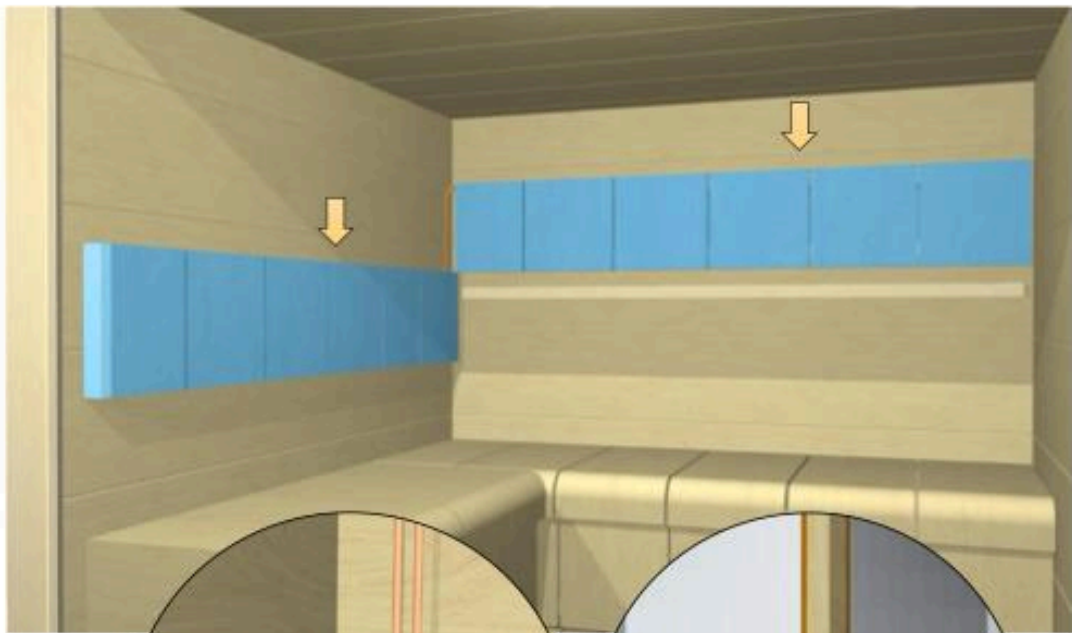
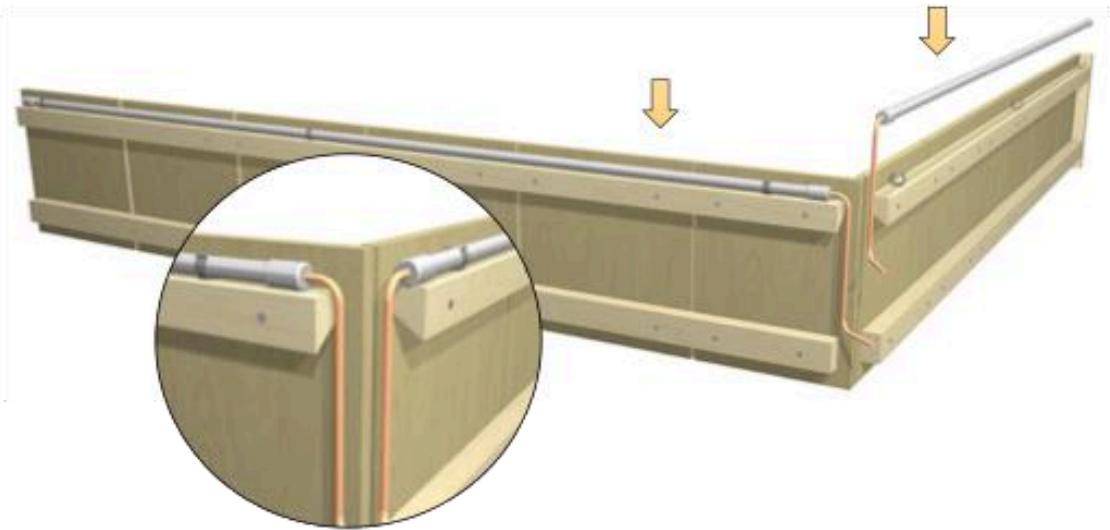

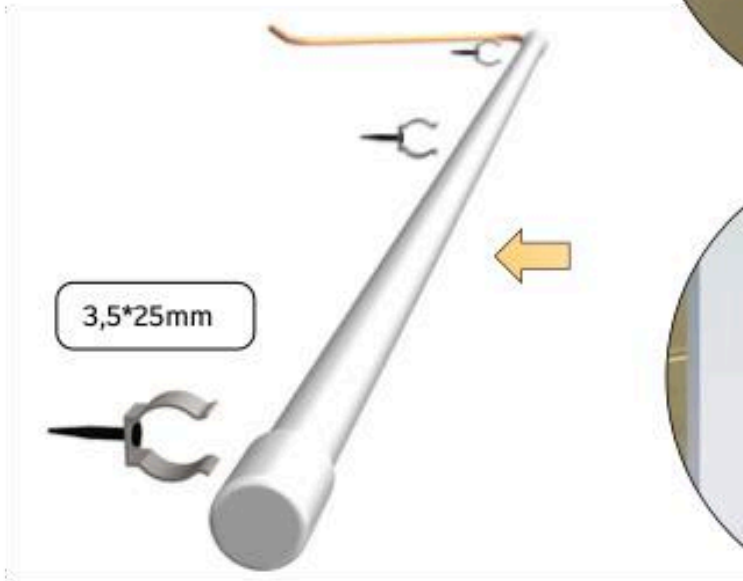
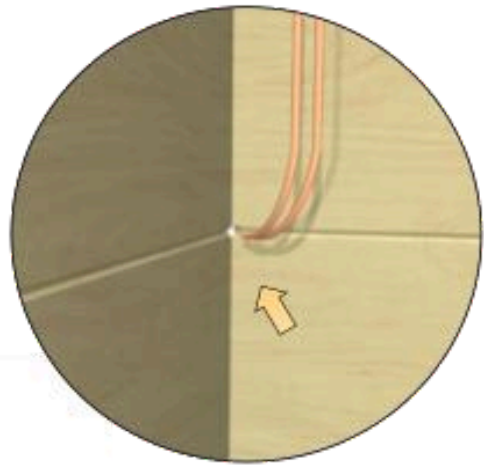
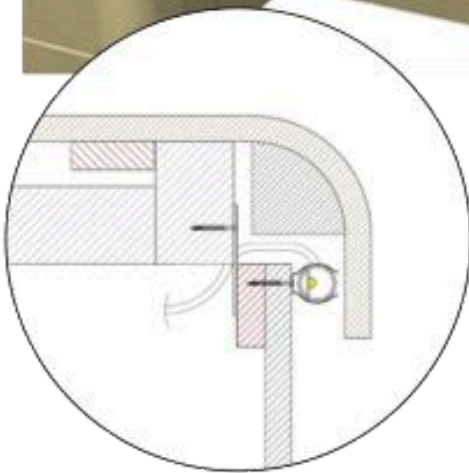
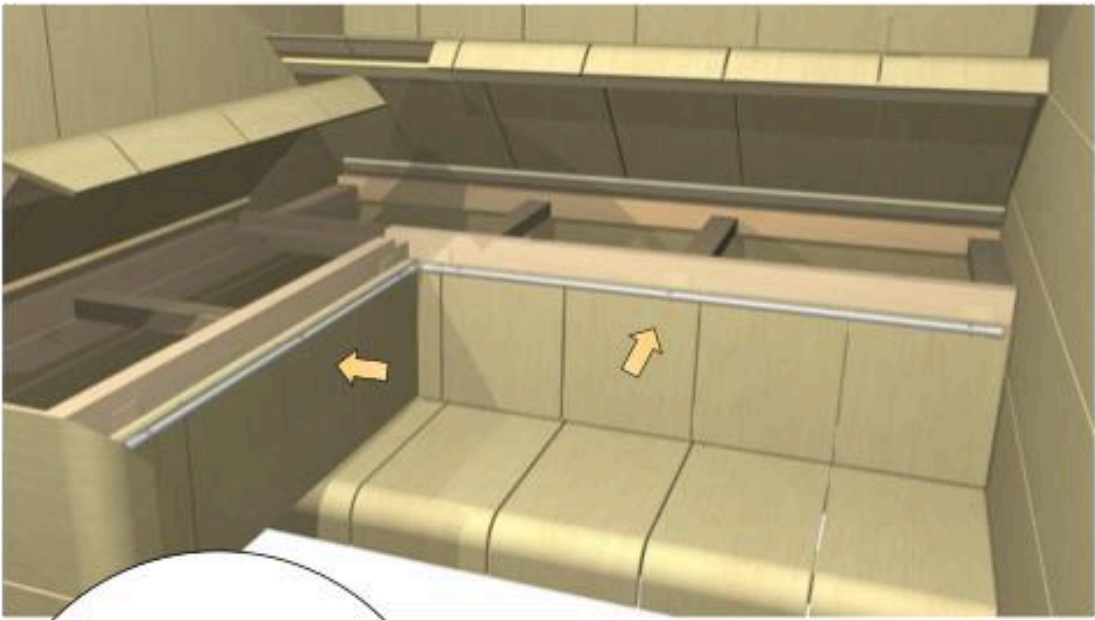

SAS21060T

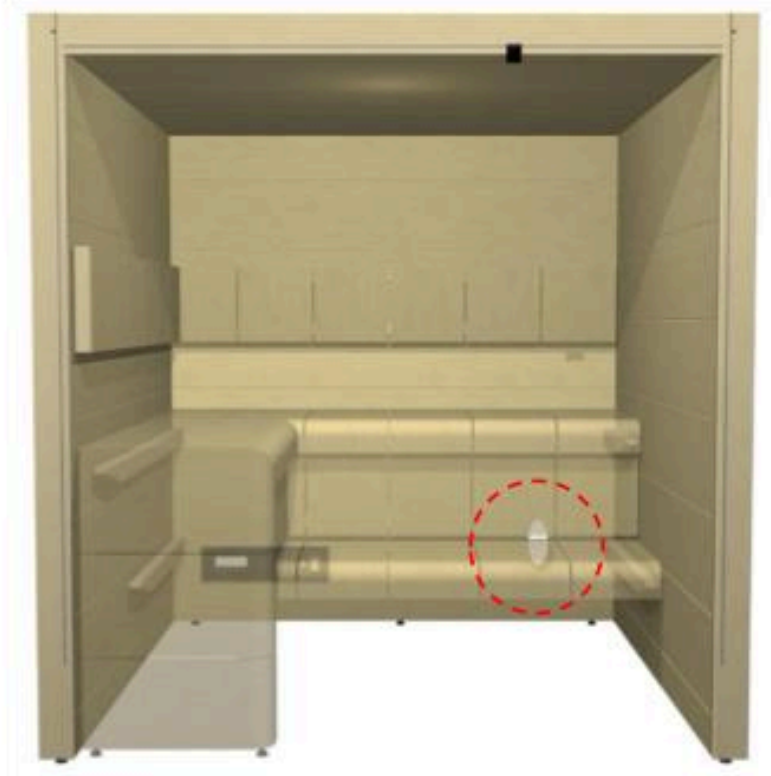
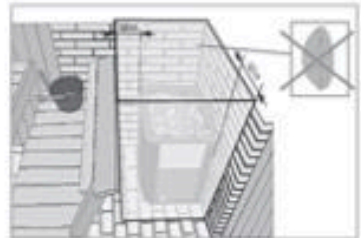
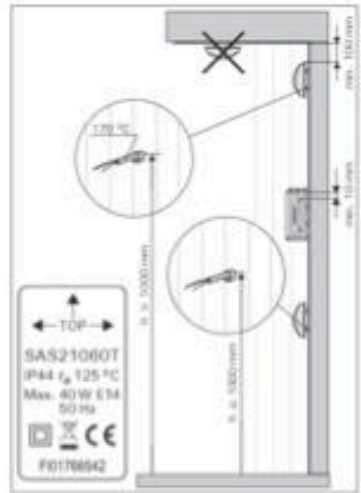
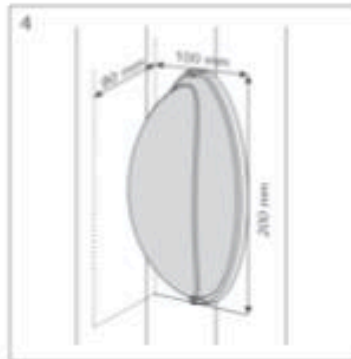
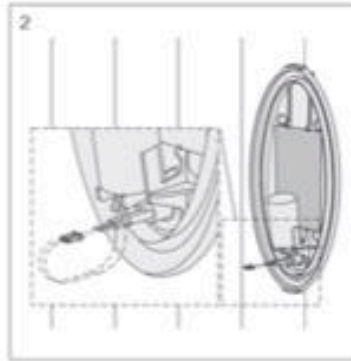
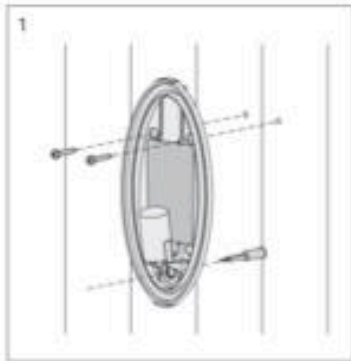

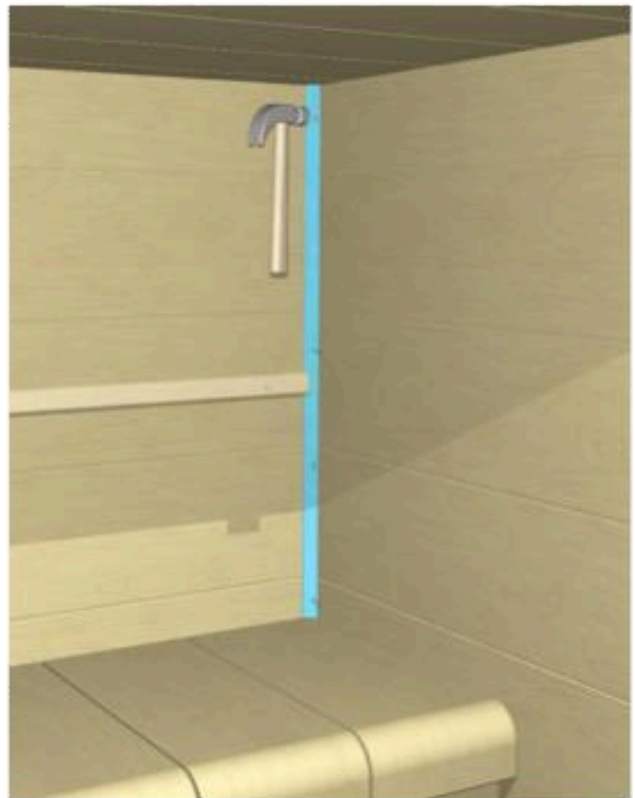
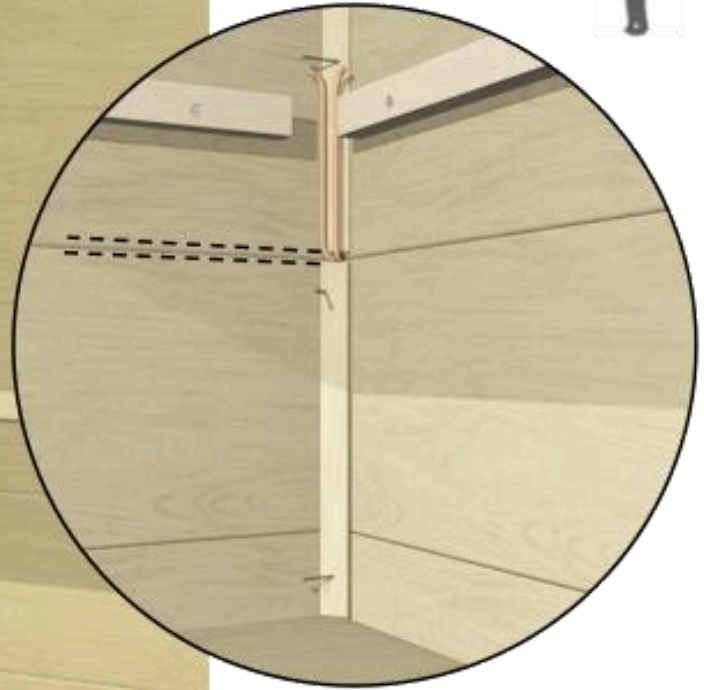
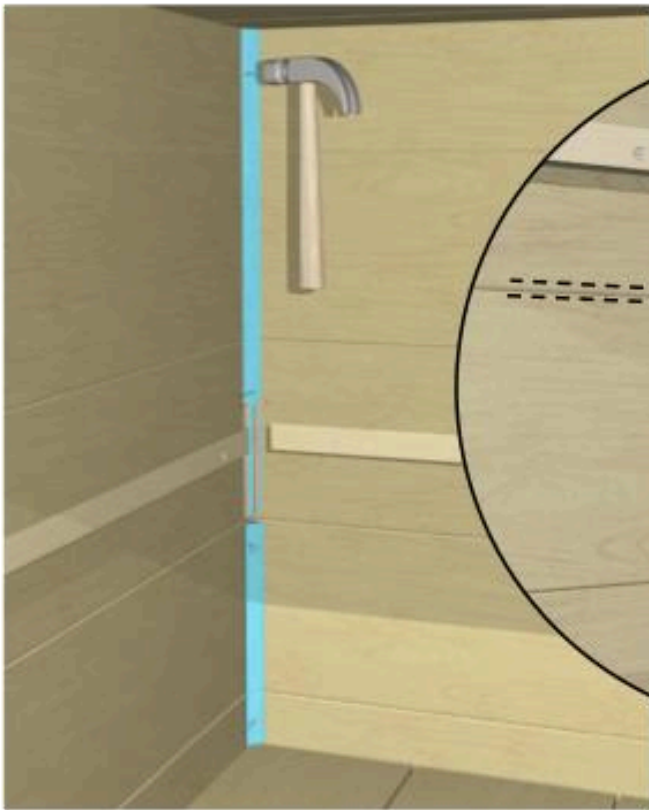

## POSITION

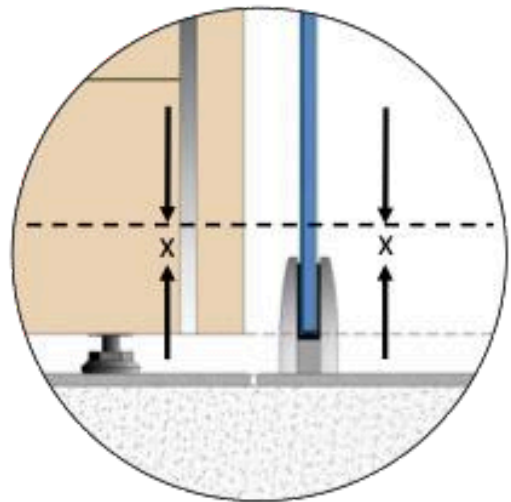
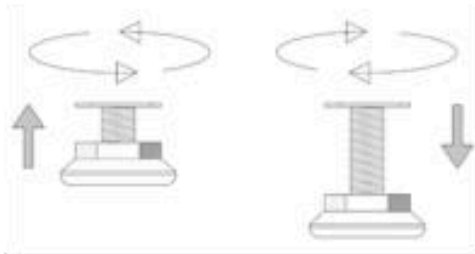
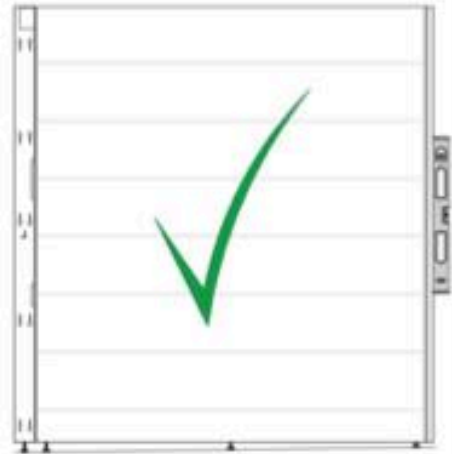
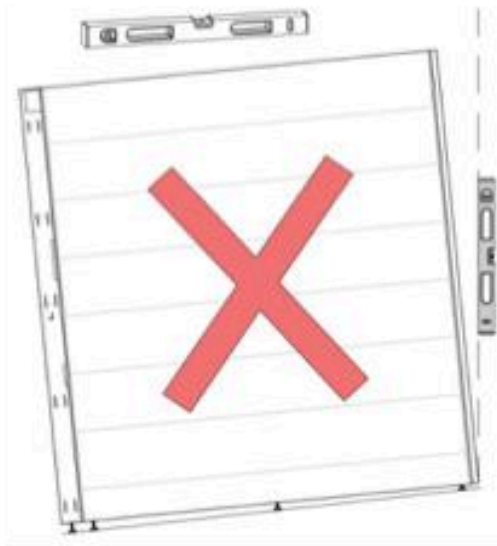

X = min 17mm – max 40mm



## GLASS FRONT

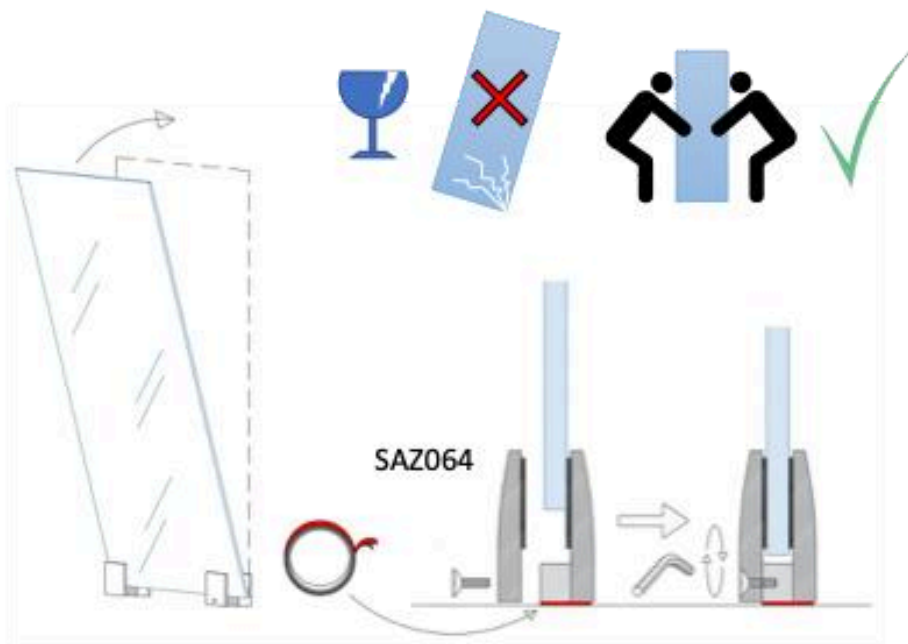

4,5\*25mm





SAZ0602



KT021  
SAZ045

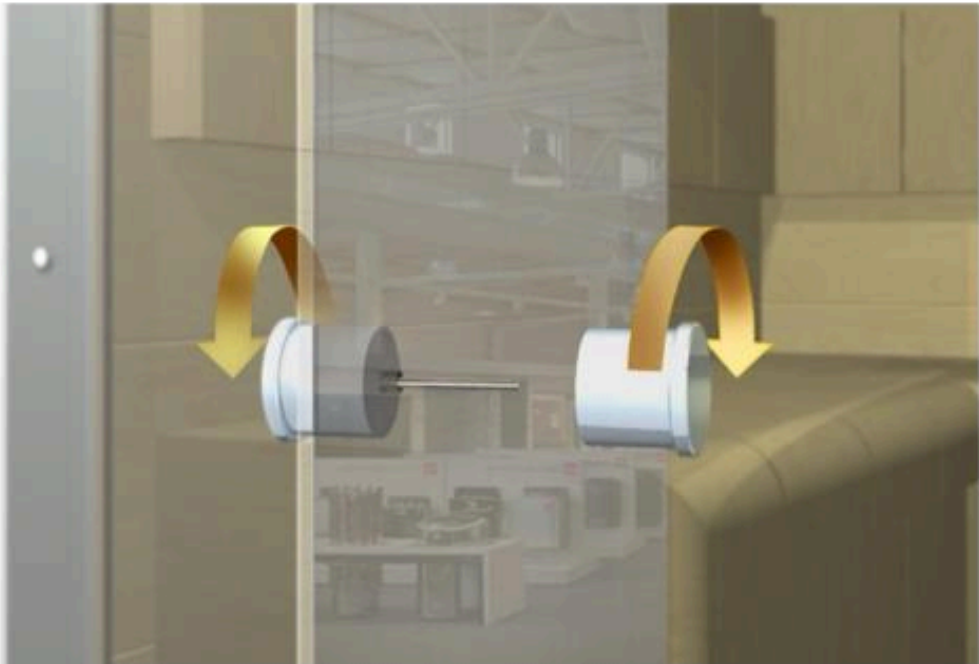

SAZ048KPL  
ZVEL-500

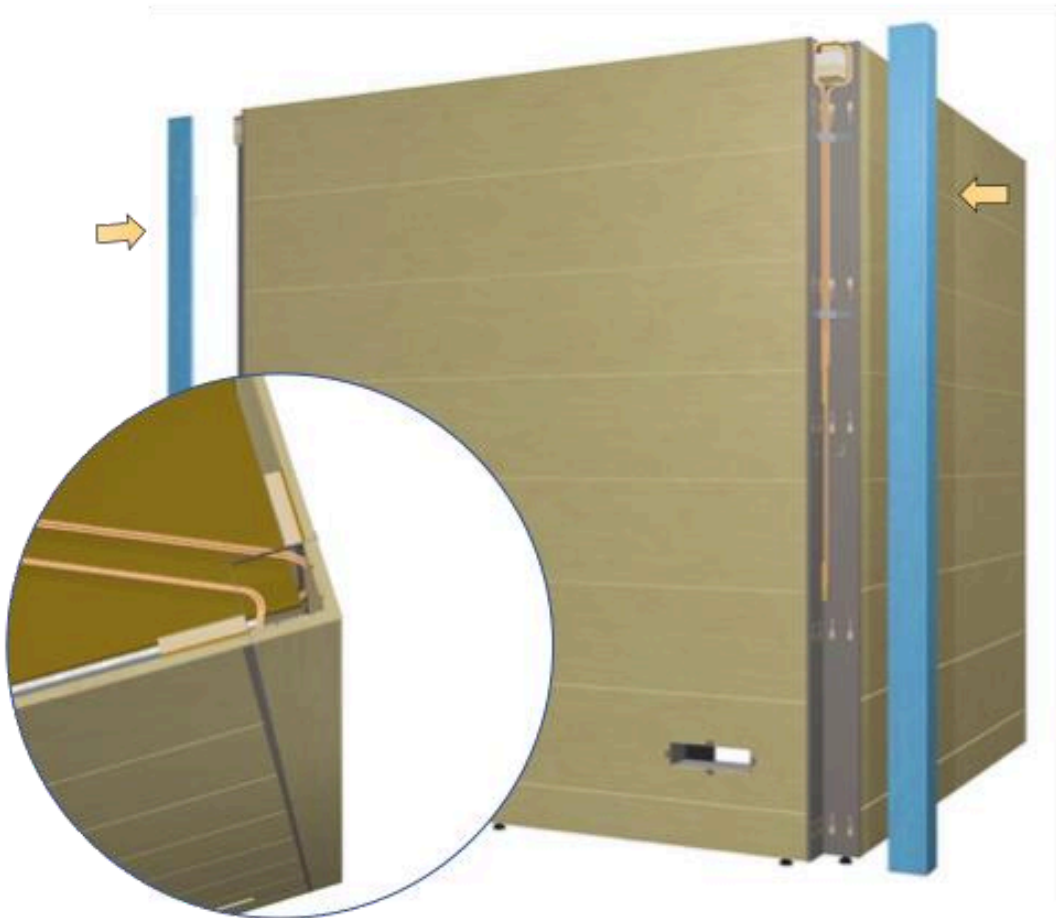
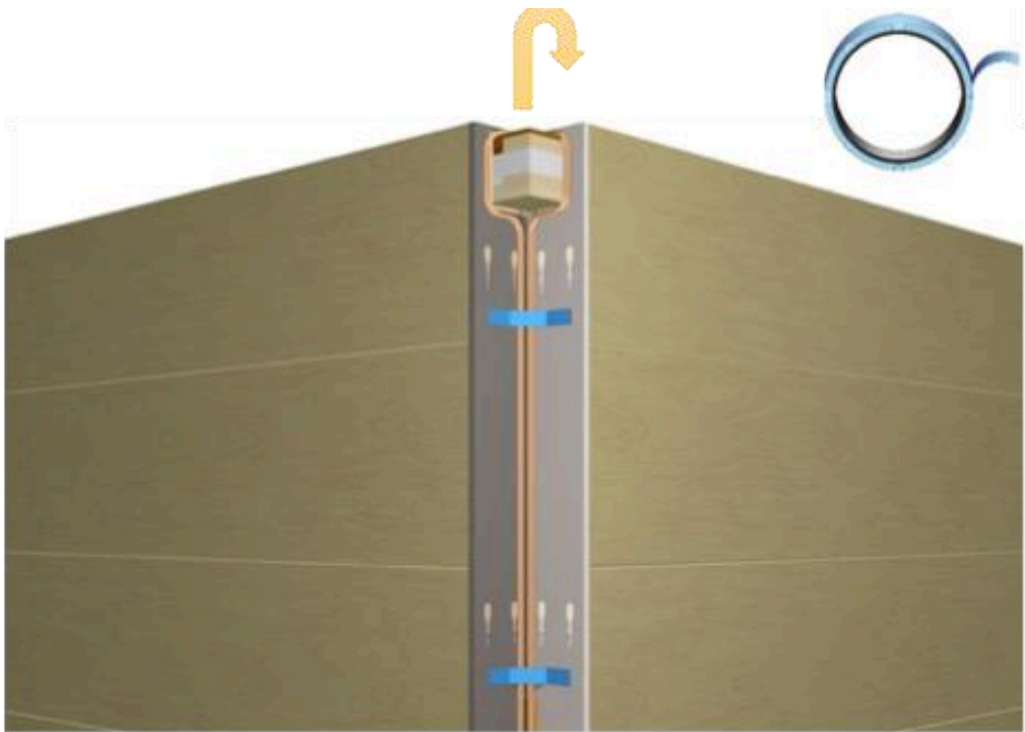

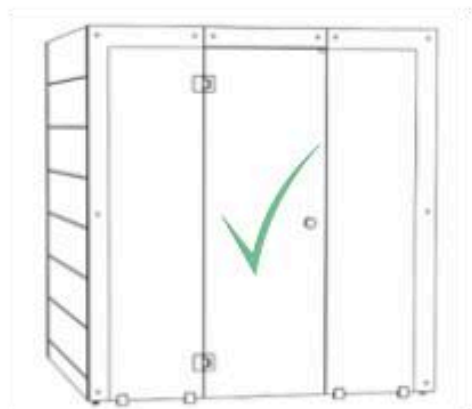
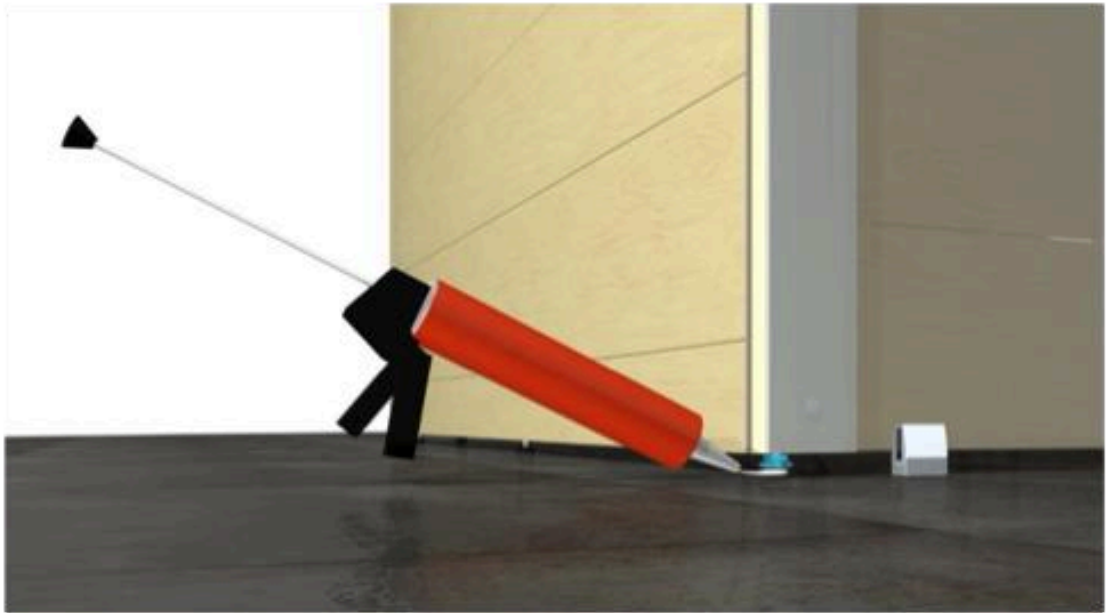
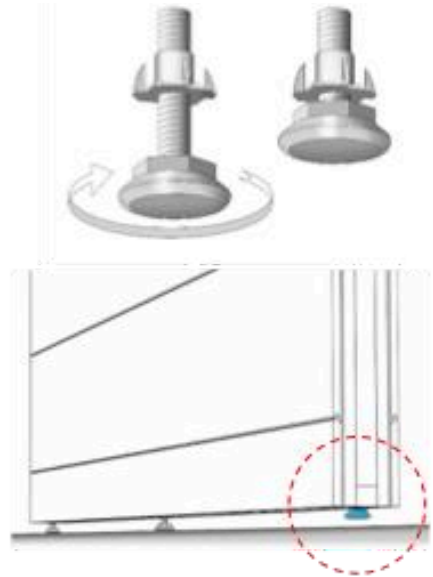
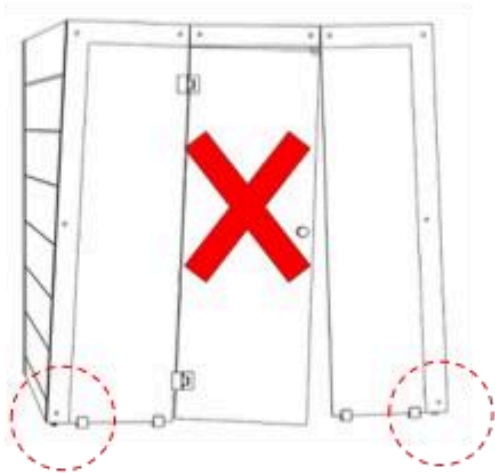

# ELECTRICS

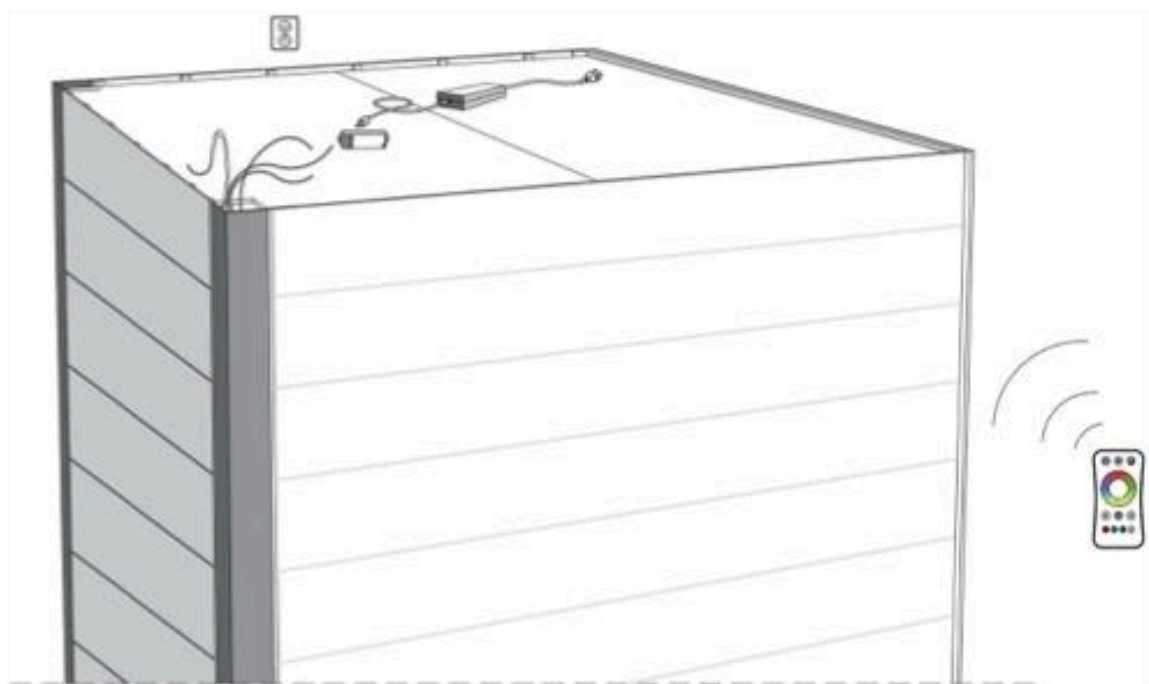
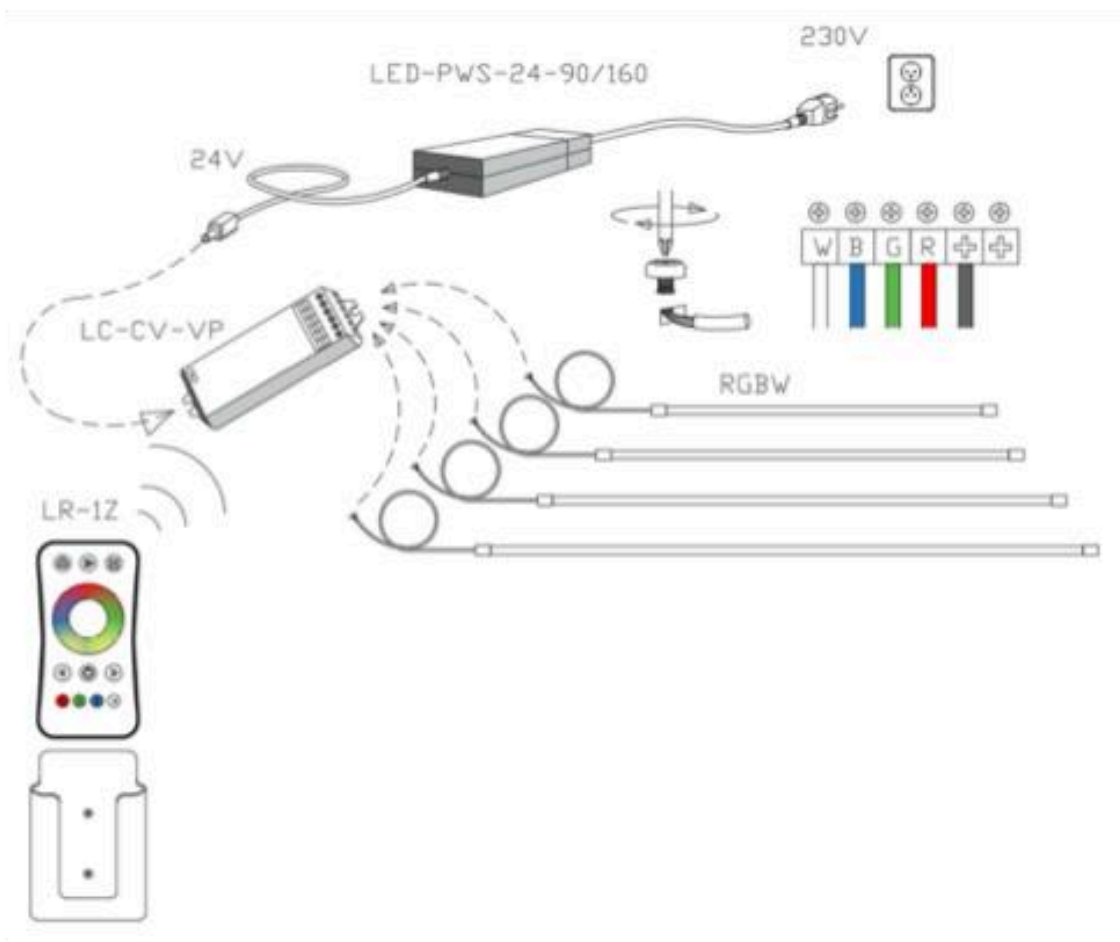

# HEATER

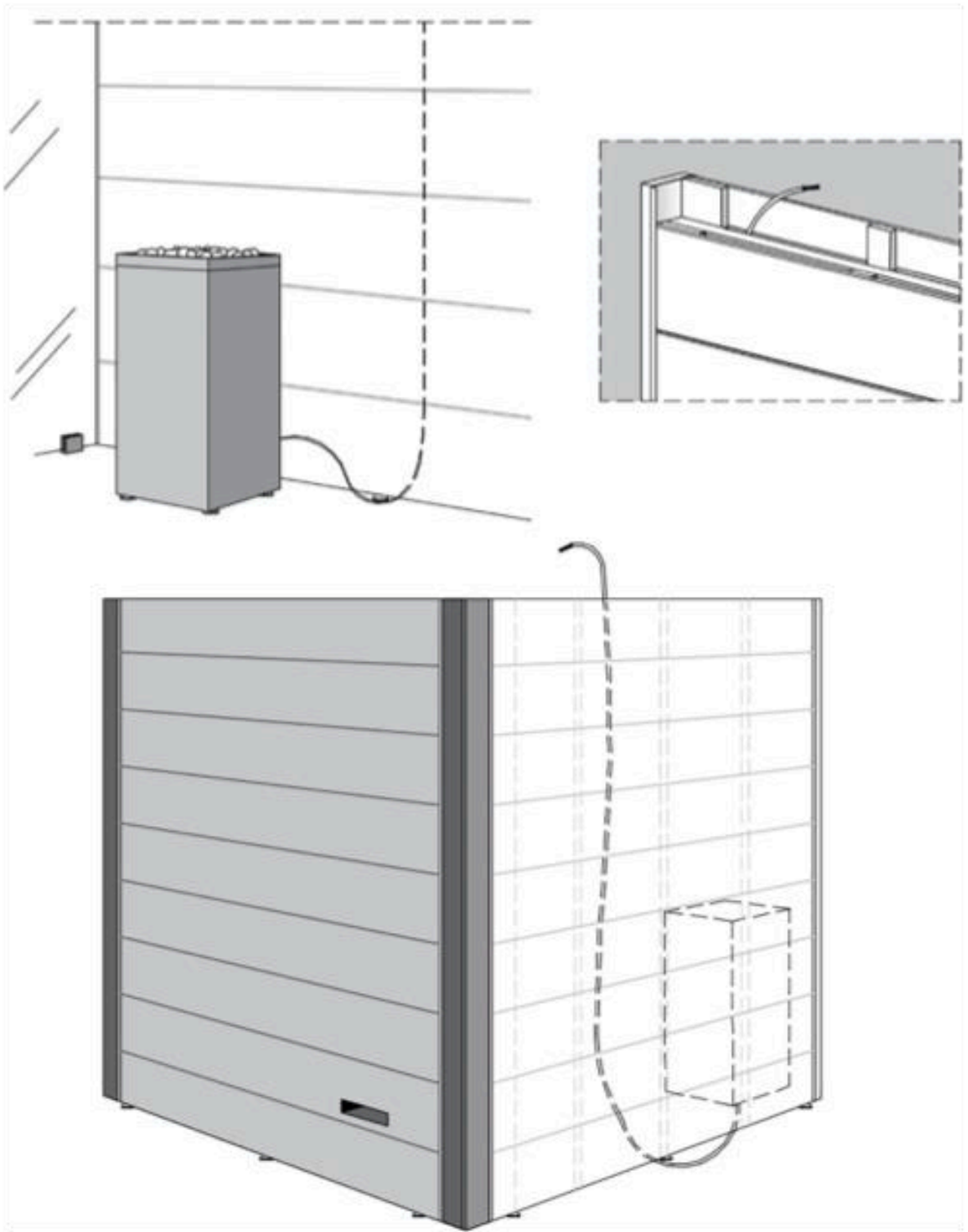



***ENJOY YOUR SAUNA!***

*Manufactured by:*

